

# Co-Treatment of Septage at STPs of Ganga Towns in Uttarakhand





# Co-Treatment of Septage at STPs of Ganga Towns in Uttarakhand



## **TITLE**

Co-Treatment of Septage at STPs of Ganga Towns in Uttarakhand

## **PUBLISHER**

NATIONAL INSTITUTE OF URBAN AFFAIRS, DELHI

## **RESEARCH PROJECT**

Sanitation Capacity Building Platform (SCBP)

Copyright © NIUA (2019)

Year of Publishing 2019

## **CONTENT**

Content for the report is developed by Indian Institute of Technology (IIT) Roorkee and edited by National Institute of Urban Affairs (NIUA), New Delhi

## **AUTHOR**

Prof. A. A. Kazmi

Dr. Ankur Rajpal

Dr. Akansha Bhatia

Mr. Raja Zubair

## **DISCLAIMER**

This is a report on Co-Treatment of Septage at STPs of Ganga Towns in Uttarakhand based on qualitative assessment of nine STPs from five cities in Uttarakhand. It analyzes STPs based on different technologies and suggests the safe addition of septage to it. The findings of the study will be used for the preparation of contextualised training material for capacity building of concerned stakeholders like decision makers, engineers from para statals and ULBs, elected representatives, private sector etc. in Uttarakhand State.

While every effort has been made to ensure the correctness of data/information used in this report, neither the authors nor NIUA accept any legal liability for the accuracy or inferences drawn from the material contained therein or for any consequences arising from the use of this material. No part of this report may be reproduced in any form (electronic or mechanical) without prior permission from or intimation to NIUA.

## **THE FULL REPORT SHOULD BE REFERENCED AS FOLLOWS**

NIUA (2019) "Co-Treatment of Septage at STPs of Ganga Towns in Uttarakhand". Text from this report can be quoted provided the source is acknowledged.

## **CONTACT**

National Institute of Urban Affairs

1st and 2nd Floor Core 4B, India Habitat Centre,

Lodhi Road, New Delhi 110003, India

Website: [www.niua.org](http://www.niua.org), [scbp.niua.org](http://scbp.niua.org)

# Contents



<b>LIST OF FIGURES .....</b>	<b>6</b>
<b>LIST OF TABLES .....</b>	<b>9</b>
<b>EXECUTIVE SUMMARY .....</b>	<b>11</b>
<b>1. INTRODUCTION AND BACKGROUND .....</b>	<b>12</b>
<b>2. METHODOLOGY .....</b>	<b>13</b>
<b>3. RESULTS AND DISCUSSION .....</b>	<b>14</b>
3.1 Septage Characterisation of Ganga Towns.....	14
3.2 A Case-Study On Strategies of Co-Treatment of Septage at 27 mld Stp, Jagjeetpur.....	15
3.3 A Case-Study on Strategies of Co-Treatment of Septage at 18 mld Stp, Sarai Haridwar.....	22
3.4 A Case-Study On Strategies of Co-Treatment of Septage at 18 Mld Stp, Kankhal Haridwar.....	29
3.5 A Case-Study On Strategies of Co-Treatment Of Septageat 20 Mld, Mothorowala Dehradun .....	35
3.6 A Case-Study On Strategies of Co-Treatment of Septage at 5 Mld Stp, Indira Nagar, Dehradun.....	42
3.7 A Case-Study On Strategies of Co-Treatment of Septageat 68 Mld Stp, Dehradun.....	48
3.8 A Case-Study on Strategies of Co-Treatment of Septage at 5 mld Stp, Tehri.....	54
3.9 A Case-Study on Strategies of Co-Treatment of Septage at 3.5 mld Stp, Tapovan Rishikesh .....	61
<b>4. SEPTAGE RECEIVING FACILITY .....</b>	<b>68</b>

## LIST OF FIGURES

<b>Figure 1:</b> Sampling locations from various town in Uttarakhand	14
<b>Figure 2:</b> Flowsheet of 27 MLD STP based on SBR at Jagjeetpur	16
<b>Figure 3:</b> Variation of inflow at STP	18
<b>Figure 4:</b> COD variation at STP	18
<b>Figure 5:</b> COD variation at STP	19
<b>Figure 6:</b> COD variation at STP	19
<b>Figure 7:</b> Actual COD loading variation, design COD load, and safe design load	21
<b>Figure 8:</b> Actual BOD loading variation, design BOD load, and safe design load	21
<b>Figure 9:</b> Actual TSS loading variation, design TSS load, and safe design load	21
<b>Figure 10:</b> Flow Diagram of 18 MLD STP at Sarai	23
<b>Figure 11:</b> Variation inflow at STP	24
<b>Figure 12:</b> COD variation at STP	25
<b>Figure 13:</b> BOD variation at STP	25
<b>Figure 14:</b> TSS variation at STP	26
<b>Figure 15:</b> Actual COD loading variation, Design COD load, and safe design load	27
<b>Figure 16:</b> Actual BOD loading variation, Design BOD load, and safe design load	28
<b>Figure 17:</b> Actual TSS loading variation, Design TSS load, and safe design load	28
<b>Figure 18:</b> Flowsheet of 18 MLD STP	29
<b>Figure 19:</b> Variation of inflow at STP	31
<b>Figure 20:</b> COD variation at STP	31
<b>Figure 21:</b> BOD variation at STP	32
<b>Figure 22:</b> TSS variation at STP	32
<b>Figure 23:</b> Actual BOD loading variation, Design BOD load, and safe design load	34
<b>Figure 24:</b> Actual TSS loading variation, Design TSS load, and safe design load	34
<b>Figure 25:</b> Please Provide heading	35
<b>Figure 26:</b> Flowsheet of 20 MLD STP	37

<b>Figure 27:</b> Variation of inflow at STP	37
<b>Figure 28:</b> COD variation at STP	38
<b>Figure 29:</b> BOD variation at STP	38
<b>Figure 30:</b> TSS variation at STP	40
<b>Figure 31:</b> Actual COD loading variation, Design COD load, and safe design load	40
<b>Figure 32:</b> Actual BOD loading variation, Design BOD load, and safe design load	41
<b>Figure 33:</b> Actual TSS loading variation, Design TSS load, and safe design load	42
<b>Figure 34:</b> Flow diagram of 5 MLD STP based on SBR process	43
<b>Figure 35:</b> Variation of inflow at STP	44
<b>Figure 36:</b> COD variation at STP	44
<b>Figure 37:</b> BOD variation at STP	45
<b>Figure 38:</b> TSS variation at STP	46
<b>Figure 39:</b> Actual COD loading variation, Design COD load, and safe design load	47
<b>Figure 40:</b> Actual BOD loading variation, Design BOD load, and safe design load	47
<b>Figure 41:</b> Actual TSS loading variation, Design TSS load, and safe design load	48
<b>Figure 42:</b> Flowsheet of 68 MLD STP	50
<b>Figure 43:</b> Variation of inflow at STP	50
<b>Figure 44:</b> COD variation at STP	51
<b>Figure 45:</b> BOD variation at STP	51
<b>Figure 46:</b> TSS variation at STP	53
<b>Figure 47:</b> Actual COD loading variation, Design COD load, and safe design load	53
<b>Figure 48:</b> Actual BOD loading variation, Design BOD load, and safe design load	53
<b>Figure 49:</b> Actual TSS loading variation, Design TSS load, and safe design load	55
<b>Figure 50:</b> Flowsheet of STP	57
<b>Figure 51:</b> Variation of inflow at STP	57
<b>Figure 52:</b> COD variation at STP	58
<b>Figure 53:</b> BOD variation at STP	68

<b>Figure 54:</b> TSS variation at STP	60
<b>Figure 55:</b> Actual BOD loading variation, Design BOD load, and safe design load	60
<b>Figure 56:</b> Actual TSS loading variation, Design TSS load, and safe design load	61
<b>Figure 57:</b> Flowsheet of 3.5 MLD SBR at Rishikesh	63
<b>Figure 58:</b> Variation of inflow at STP	63
<b>Figure 59:</b> COD variation at STP	64
<b>Figure 60:</b> BOD variation at STP	64
<b>Figure 61:</b> TSS variation at STP	66
<b>Figure 62:</b> Actual COD loading variation, Design COD load, and safe design load	66
<b>Figure 63:</b> Actual BOD loading variation, Design BOD load, and safe design load	66
<b>Figure 64:</b> Actual TSS loading variation, Design TSS load, and safe design load	67
<b>Figure 65:</b> Typical photographs of the septage receiving station	68
<b>Figure 66:</b> Typical plan and elevation of a septage receiving station	69



## LIST OF TABLES

<b>Table 1:</b> Septage characteristics in Ganga Towns of Uttarakhand state	14
<b>Table 2:</b> Septage Characteristics	15
<b>Table 3:</b> Inlet and Outlet Water Quality Parameters	17
<b>Table 4:</b> Unit Sizes of STP	17
<b>Table 5:</b> Results of Composite Sample	20
<b>Table 6:</b> Design COD, BOD, and TSS Loading	20
<b>Table 7:</b> Loading condition and disposing criteria	22
<b>Table 8:</b> Inlet and Outlet water quality parameters	23
<b>Table 9:</b> Unit sizes of STP	24
<b>Table10:</b> Results of Composite Sample	26
<b>Table11:</b> Design COD, BOD, and TSS Loading	27
<b>Table 12:</b> Loading Condition and Disposing Criteria	29
<b>Table13:</b> Inlet and Outlet Water Quality Parameters	30
<b>Table14:</b> Unit Sizes of STP	30
<b>Table 15:</b> Results of Composite Sample	33
<b>Table16:</b> Design COD, BOD, and TSS Loading	33
<b>Table 17:</b> Loading condition and disposing criteria	33
<b>Table 18:</b> Inlet and Outlet Water Quality Parameters	35
<b>Table 19:</b> Unit Sizes of STP	36
<b>Table 20:</b> Results of Composite Sample	39
<b>Table 21:</b> Design COD, BOD, and TSS Loading	39
<b>Table 22:</b> Loading condition and disposing criteria	41
<b>Table 23:</b> Inlet and Outlet Water Quality Parameters	42
<b>Table 24:</b> Unit Sizes of STP	43
<b>Table 25:</b> Results of Composite Sample	45
<b>Table 26:</b> Design COD, BOD, and TSS Loading	46

<b>Table 27:</b> Loading condition and disposing criteria	48
<b>Table 28:</b> Inlet and Outlet Water Quality Parameters	49
<b>Table 29:</b> Unit Sizes of STP	49
<b>Table 30:</b> Results of Composite Sample	52
<b>Table 31:</b> Design COD, BOD, and TSS Loading	52
<b>Table 32:</b> Loading condition and disposing criteria	54
<b>Table 33:</b> Inlet and Outlet Water Quality Parameters	55
<b>Table 34:</b> Unit sizes of STP	56
<b>Table 35:</b> Results of Composite Sample	59
<b>Table 36:</b> Design COD, BOD, and TSS Loading	59
<b>Table 37:</b> Loading condition and disposing criteria	61
<b>Table 38:</b> Inlet and outlet water quality parameters	62
<b>Table 39:</b> Unit Sizes of STP	62
<b>Table 40:</b> Results of Composite Sample	65
<b>Table 41:</b> Design COD, BOD, and TSS Loading	65
<b>Table 42:</b> Loading condition and disposing criteria	67

# Executive Summary

SPMG Uttarakhand contacted IIT, Roorkee to conduct the feasibility study on co-treatment of septage in the functional Sewage Treatment Plants (STPs) of Ganga towns. The main objective of the study was to assess the quantity of septage that can be added to the working STPs based on different technologies without compromising the effluent quality.

Since there is a wide variation in the quality of septage due to different desludging frequencies, therefore septage samples were collected from several locations of Ganga towns and analysed for critical parameters.

The feasibility study of co-treatment was carried out by conducting field visits, measuring 24-h flow, water quality, composite sampling, incoming and outgoing load analysis in terms of Chemical Oxygen Demand (COD), Biochemical Oxygen Demand (BOD), and Total Suspended Solids (TSS).

It was observed that average septage COD, BOD and TSS values were 30,370 mg/L, 18,372 mg/L, and 28,308 mg/L respectively. These results shows that septage is highly concentrated in Uttarakhand towns due to the very low frequency of desludging septic tanks. Based on the above values, the average septage (that can be co-treated at the STP) COD, BOD, and TSS were assumed as 30,000 mg/L, 20,000 mg/L & 30,000 mg/L, respectively.

For devising strategies of co-treatment of septage, the design data in terms of capacity, COD, BOD and TSS loading was collected from Uttarakhand Peyjal Nigam. To assess the factual operating condition of plant operation, 24-h flow and water quality monitoring of STP was conducted. The design and actual loading (both hydraulic and organic) with respect to elapsed time is assessed and strategies are formulated for safe co-treatment of septage at the STP. The strategies for co-treatment of septage for each STP is summarised as follows;

S. No.	Name of STP	Capacity (MLD)	Technology	Date of Monitoring & Sampling	Actual Flow (MLD)	Septage addition m <sup>3</sup> /d (Tankers/d)	Septage Addition (Timings)	Septage Storage Facility
1	Jagjeetpur, Haridwar	27	Primary Clarifier + SBR	6-7 <sup>th</sup> June 2019	21.8	49.5 (16.w5 Tankers/day)	23:00–10:00 AM	Yes
2	Sarai, Haridwar	18	SBR	6-7 <sup>th</sup> June 2019	15.8	54 (18 tankers/day)	19:00 to 7 :00 am	Yes
3	Kankhal, Haridwar	18	Conventional Activated Sludge	6-7 <sup>th</sup> June 2019	19.1	30 (10 Tankers/day)	23:00 – 09:00 AM	Yes
4	Mothorowala, Dehradun	20	SBR	19-20 June 2019	9.52	48 (16 tankers/day)	13:00 to 21:00	Yes
5	Indira Nagar, Dehradun	5.0	SBR	8-9 July 2019	8.4	9 (3 tankers/day)	1:00 am - 10:00 am	Yes
6	Kargi, Dehradun	68	SBR	14-15 June 2019	17.6	336 (112 tankers/day)	16:00 – 8:00 am	Yes
7	Tehri	5.0	Extended Aeration	1-7 <sup>th</sup> July 2019	2.28	28.5 (9.5 tankers/day)	6:00 am – 1:00 am	No
8	Tapovan, Rishikesh	3.5	SBR	13-14 <sup>th</sup> August 2019	0.62	30 (10 tankers/day)	Anytime (24 h)	No

# 1. Introduction and Background

---

As per the directions of Hon'ble National Green Tribunal (NGT) regarding septage management, Uttarakhand state government issued a septage management protocol. As per the provisions made in septage management protocol, septage from the individual or common septic tanks should be collected at a timely interval of 1-2 years and appropriately treated before its safe disposal. Co-treatment of septage in the existing STPs of Ganga towns is one option that can be explored. Co-treatment of septage at STP can be achieved either via emptying septage at manholes/Sewage Pumping Station (SPS) or directly at the STP by the registered septage desludging operator.

A feasibility study was proposed to assess the quantity of septage that can be added to the existing STPs based on the quantity and quality of the septage being received and the current operational status of the STP.

Based on the above, SPMG Uttarakhand contacted IIT, Roorkee to conduct this feasibility study of co-treatment of septage in Ganga towns. Broad objectives of this study are as follows:

1. Technical analysis of existing STPs at Haridwar, Dehradun, New Tehri and Tapovan (Rishikesh) concerning design parameters, current incoming load, etc.,
2. Sampling and qualitative analysis of septage from 15 different usages of septic tanks (Individual/community/public toilets) from different locations (residential or commercial) in each of the above five cities.
3. Suggestion of potential discharge points where septage could be added for co-treatment, either at STPs or SPS/manholes,
4. Suggestion on the requirement of any additional pre-treatment units, if any, e.g. equalization tank/holding tank for controlled addition of septage.

## 2. Methodology

---

There is a huge variation in the quality of septage all over the world and the characteristics of the septage primarily depends on the frequency of desludging of the septic tanks. Hence septage samples were collected from several locations of Ganga towns and analysed for critical parameters.

The feasibility study was carried out by conducting field visits, measuring 24-h flow, water quality, composite sampling of wastewater at the STPs and by analysing the incoming and outgoing load (both organic and hydraulic) in terms of COD, BOD, and TSS. The plant and design details were obtained from Uttarakhand Jal Sansthan and Jal Nigam officials.

Finally, strategies for septage addition to the STPs were proposed based on the STP design and actual organic and hydraulic loading.

# 3. Results and Discussion

## 3.1 Septage Characterisation of Ganga Towns

The septage samples were collected from the four towns, Haridwar, Dehradun, Tehri, and Rishikesh. These are the Ganga towns in Uttarakhand (Figure 1).

Figure 1: Sampling locations from various town in Uttarakhand



Septage samples were tested for various parameters such as COD, BOD, TSS, TS, TVS, TSS, VSS, NH3-N, TP, oil and grease. The results are shown in Table 1.

COD varies between 21,425 mg/L to 45,745 mg/L with an average value of **30,370 mg/L**, BOD varies between 14,140 mg/L to 28,381 mg/L with an average value of **18,372 mg/L** and TSS varies between 7,081 mg/L to 63,710 mg/L with an average value of **28,308 mg/L** as shown in Table 1. Septage results show significant variation in quality parameters. The analysed septage values are compared with the US EPA and Europe/Canada septage values Table 2. **It was observed that septage is highly concentrated in Uttarakhand towns attributed to the very low frequency of septic tanks cleaning.**

Based on the above values, the average septage COD, BOD, and TSS values are assumed as 30,000 mg/L, 20,000 mg/L & 30,000 mg/L, respectively.

Table 1: Septage characteristics in Ganga Towns of Uttarakhand state

City	Sampling location	pH	Alkalinity (mg/L)	O&G (mg/L)	COD (mg/L)	BOD (mg/L)	TSS (mg/L)	VSS (mg/L)	NH <sub>3</sub> -N (mg/L)	TKN (mg/L)	TN (mg/L)	T-P (mg/L)
Dehradun	1. Niranjapur	11.7	524	2310	45050	28381	7081	4310	98	112	113	310
	2. Brahmaputra	12.9	714	4309	27010	17016	31011	27001	115	122	123	620
	3. Triveni, Bihar	10.6	534	5101	45745	19117	63710	55010	171	189	190	410
	4. Dehaj	9.9	419	5310	21425	15414	27109	21014	141	159	160	437
	5. Bengali Kothi	11.7	721	5219	26575	21134	28101	19017	121	135	136	508

City	Sampling location	pH	Alkalinity (mg/L)	O&G (mg/L)	COD (mg/L)	BOD (mg/L)	TSS (mg/L)	VSS (mg/L)	NH <sub>3</sub> -N (mg/L)	TKN (mg/L)	TN (mg/L)	T-P (mg/L)
Haridwar	6. Haridwar (Khankal)	9.9	713	4377	23760	14140	22043	16013	106	119	120	519
	7. Haridwar (Main bazaar)	10.1	742	4312	21530	14319	23017	14027	112	123	124	613
Tehri	8. Nirmalawas, Dhunghidar	8.6	450	3936	22095	16079	21196	13726	106	132	133	453
	9. Anchal Dairy, New tehi	9.4	430	4120	23500	17719	21346	13803	108	129	130	562
Rishikesh (Tapovan)	10. LaxmanJhula (lane -4)	8.9	512	2367	36130	19876	32006	18960	119	145	146	438
	11. Laxman Jhula (lane 2)	8.6	432	3456	41250	18895	34768	17685	156	174	175	419
<b>Average values</b>					<b>30370</b>	<b>18372</b>	<b>28308</b>	<b>20051</b>	<b>123</b>	<b>140</b>	<b>141</b>	<b>481</b>

**Table 2: Septage Characteristics**

Parameter	United States				Europe/Canada				EPA Mean	Suggested Design Value
	Average	Minimum	Maximum	Variance	Average	Minimum	Maximum	Variance		
TS	34,106	1,132	130,475	115	33,800	200	123,860	619	38,800	40,000
TVS	23,100	353	71,402	202	31,600	160	67,570	422	25,260	25,000
TSS	12,862	310	93,378	301	45,000	5,000	70,920	14	13,000	15,000
VSS	9,027	95	51,500	542	29,900	4,000	52,370	13	8,720	10,000
BOD <sub>5</sub>	6,480	440	78,600	179	8,343	700	25,000	36	5,000	7,000
COD	31,900	1,500	703,000	469	28,975	1,300	114,870	88	42,850	15,000
TKN	588	66	1,060	16	1,067	150	2,570	17	677	700
NH <sub>3</sub> -N	97	3	116	39	-	-	-	-	157	150
Total P	210	20	760	38	155	20	636	32	253	250
Alkalinity	970	522	4,190	8	-	-	-	-	-	1,000
Grease	5,600	208	23,368	112	-	-	-	-	9,090	8,000
pH	-	1.5	12.6	8	-	5.2	9.0		6.9	6.0
LAS	-	110	200	2	-	-	-		157	150

(Source: CPHEEO Manual 2013)

## 3.2.A Case-Study On Strategies of Co-Treatment of Septage at 27 mld STP, Jagjeetpur

### 3.2.1. Introduction

The 27 MLD STP was commissioned in April 2010. The STP has a primary settling unit followed by a Sequencing Batch Reactor (SBR). STP is comprised of a receiving chamber, coarse screen (manual and mechanical), raw sewage sump, pump house, stilling chamber, fine screen (manual and mechanical), grit chamber, parshall flume, primary clarifier, SBR basin, chlorine contact tank, sludge sump, sludge thickener, and centrifuge. Sludge digesters existing at the STP are used for anaerobic digestion of sludge.

### 3.2.2 Flowsheet

The flowsheet of the STP is given in Figure 2.

Figure 2: Flowsheet of 27 MLD STP based on SBR at Jagjeetpur

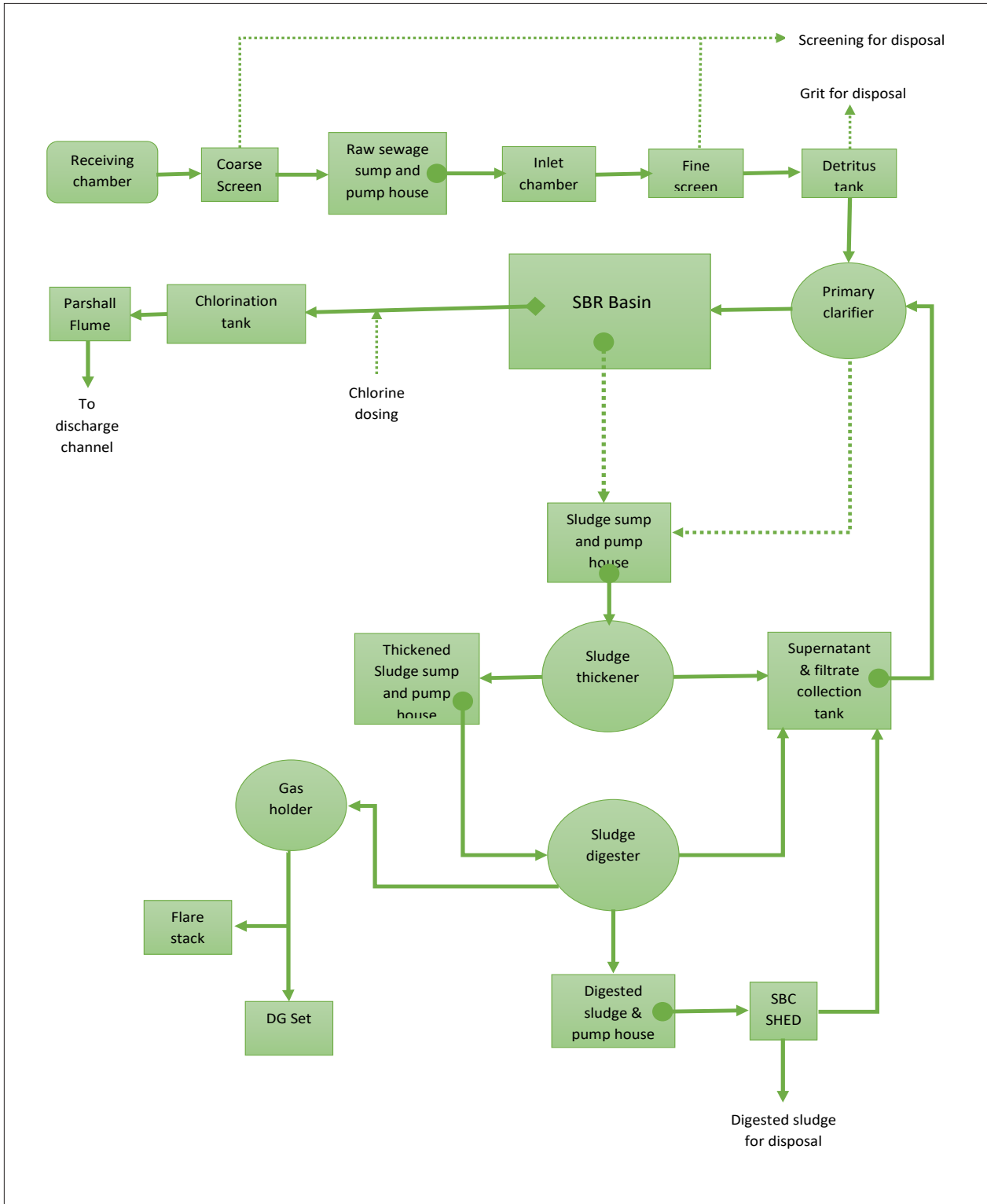



### 3.2.3. Design parameters & unit sizes

The STP was designed for an average flow of 27 MLD and a peak flow of 60.75 MLD. The design inlet and outlet water quality parameters are summarized in Table 3. The unit sizes are summarized in Table 4.

**Table 3: Inlet and Outlet Water Quality Parameters**

S.No.	Parameter	Units	Influent	Effluent
1.	BOD	mg/L	250	<10
2.	COD	mg/L	450	<100
3.	TSS	mg/L	450	<10
4.	TKN	mg/L	15	-
5.	NH <sub>4</sub> -N	mg/L	8	-
6.	T-P	mg/L	6	-
7.	Fecal coliforms	MPN/100mL	1x10 <sup>6</sup>	-

**Table4: Unit Sizes of STP**

S. No.	Description	Dimensions	No.
1.	Receiving Chamber	7.2 m x 2.8 m x 1.25 m	1
2.	Coarse Bar Screen Channel	4.0 m x 8.0 m x 1.20 m	2+1
3.	Raw Sewage Collection Sump	9.5 m Dia x 3.0 m	1
4.	Pump House & MCC-1	9.5 m x 7.2 m x 4.0 m	1
5.	Inlet Chamber to Fine Bar Screen	4.5 m x 2.8 m x 2.0 m	1
6.	Fine Bar Screen Channels	4.0 m x 0.8 m x 0.8 m	2+1
7.	Detritus Tanks	6.5 m x 6.5 m x 0.9 m	2
8.	Outlet Chamber to Detritus Tank	2.5 m x 1.2 m x 0.9 m	1
9.	Distribution Chamber to Primary Clarifier	5.0 m x 2.5 m x 2.0 m	1
10.	Primary Clarifier	24.0 m Dia x 3.0 m	1
11.	CTech Basins	39.0 m x 19.5 m x 4.1 m SWD	4
12.	Disinfection Tank	36.0 m x 12.0 m x 2.2 m	1
13.	Parshall Flume	0.3 m Throat Width	1
14.	Sludge Sump	6.2 m x 6.2 m x 3.0 m	1
15.	Pump & Blower Room	10.0 m x 5.0 m x 4.0 m	1
16.	MCC Room-3	5.5 m x 3.5 m x 4.0 m	1
17.	Sludge Thickener (New)	14.0 m Dia x 4.0 m	1
18.	Sludge Thickener (Existing)	11.4 m Dia x 3.0 m	2
19.	Thickened Sludge Sump	3.5 m x 3.5 m x 3.0 m SWD	1
20.	Anaerobic Digesters (Existing)	18.0 m Dia x 7.9 m	2
21.	Digested Sludge Sump	3.5 m x 3.5 m x 3.0 m	1
22.	Blower Room for CTech	23.0 m x 6.5 m x 5.5 m	1

### 3.2.4. Flow and water quality analysis

#### Flow Variation

Flow variation is required for obtaining peak and lean flows. Peak factor is one of the essential criteria for designing of a preliminary treatment unit and the flexibility of the biological process to handle peak flows. The STP received an average flow of 908 m<sup>3</sup>/h or 21.8 MLD whereas the peak flow at the STP was measured as 1155 m<sup>3</sup>/h with peak factor of 1.3 on 6 - 7<sup>th</sup> June 2019. However, this peak factor is lower than the design peak factor. Figure 3 shows the flow variation.

Figure 3: Variation of inflow at STP

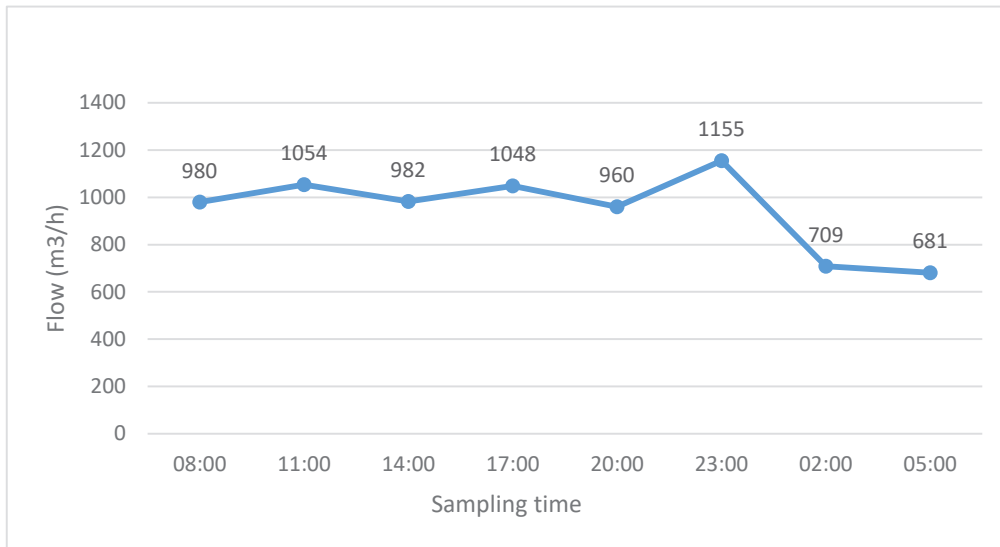

#### COD Variation

Figure 4 shows the COD variation in raw sewage, primary clarifier effluent, and treated effluent. The minimum and maximum COD in the raw sewage varied from 210 mg/L to 373 mg/L with a composite value of 301 mg/L. The time variable effluent COD concentration is in the range of 42 mg/L to 66 mg/L with a composite value of 53 mg/L.

Figure 4: COD variation at STP

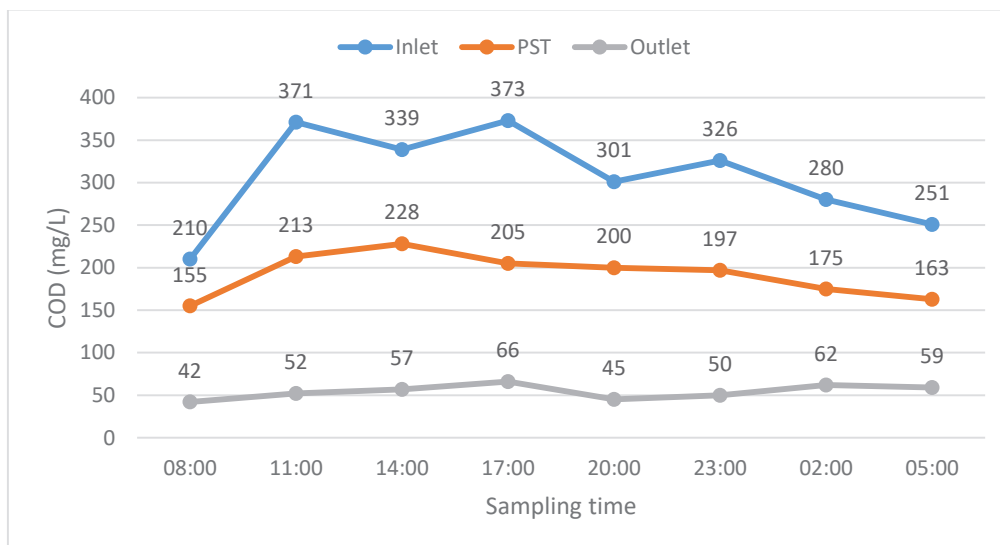

### BOD Variation

Figure 5 shows the BOD variation in raw sewage, primary clarifier effluent, and treated effluent. The minimum and maximum BOD in the raw sewage varied from 121 mg/L to 221 mg/L with a composite value of 185 mg/L. The time variable effluent BOD concentration is in the range of 10 mg/L to 13 mg/L with a composite value of 11 mg/L.

Figure 5: BOD variation at STP

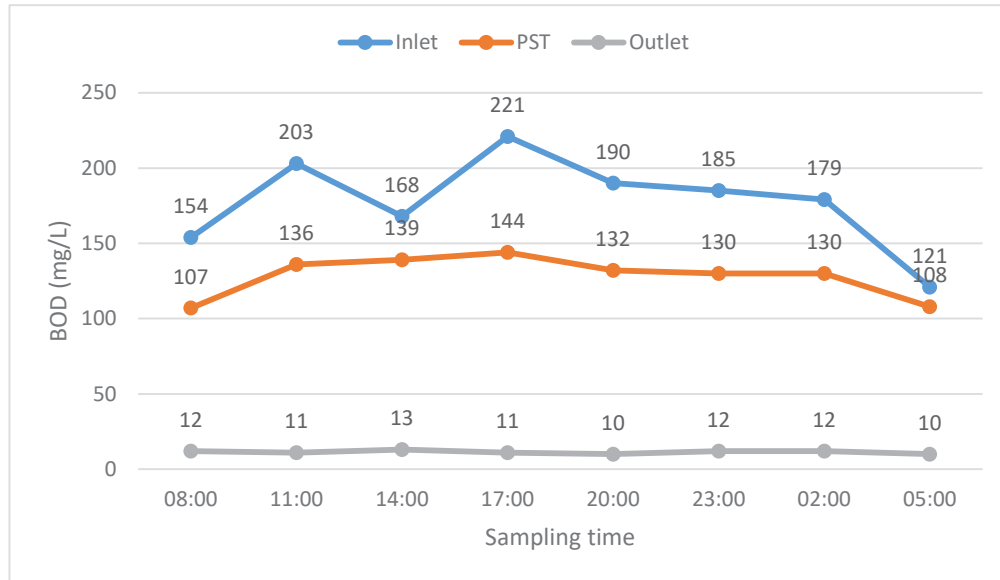

### TSS Variation

Figure 6 shows the TSS variation in raw sewage, primary clarifier effluent, and treated effluent. The minimum and maximum TSS in the raw sewage varied from 131 mg/L to 201 mg/L with a composite value of 158 mg/L. The time variable effluent TSS concentration is in the range of 8 mg/L to 11 mg/L with a composite value of 10 mg/L.

Figure 6: TSS variation at STP

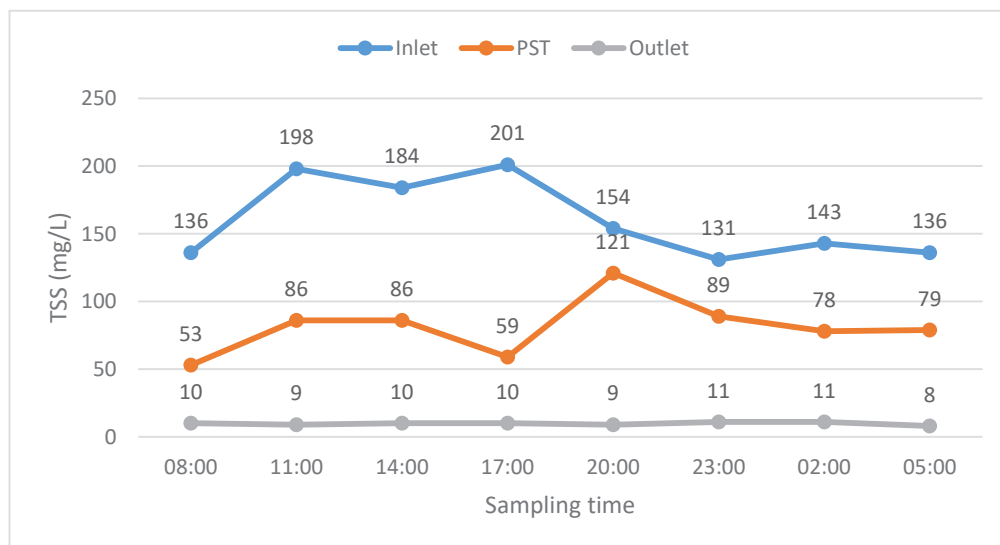

### 3.2.5 Composite sampling & analysis

For composite sampling, representative samples were collected at the regular time interval of 3-h on 6-7<sup>th</sup> June 2019. The flow rate was recorded by the flowmeter/pump operation. The representative samples were integrated by mixing the portions of the individual samples relative to the flowrate at sampling time. Analyses of alkalinity, COD, BOD, TSS, NH<sub>4</sub>-N, NO<sub>3</sub>-N, and PO<sub>4</sub>-P were carried out as per the Standard Methods (APHA, 2012) and are presented in Table 5. The results show that almost all parameters satisfied the design outlet quality.

Table 5: Results of Composite Sample

S.No.	Parameters	Unit	Raw sewage	PST effluent	Outlet	Desired Effluent Quality
1	Alkalinity as CaCO <sub>3</sub>	mg/L	320	320	250	-
2	pH	-	7.5	7.4	7.7	-
3	Turbidity	NTU	122	88	2.1	-
4	COD	mg/L	301	183	53	100
5	BOD	mg/L	185	151	11	10
6	TSS	mg/L	158	74	10	10
7	NH <sub>4</sub> -N	mg/L	20	18	3	-
8	NO <sub>3</sub> -N	mg/L	0.2	0.3	5.7	-
9	TN	mg/L	24.3	23.9	9.8	-
10	PO <sub>4</sub> -P	mg/L	2.1	2	1.1	-

### 3.2.6 Strategies for septage addition for design and actual COD, BOD and TSS loadings

The design COD, BOD, and TSS loadings are summarized in the following Table 6. The safe load for septage addition is assumed as 80% of the design load. The safety factor is taken for consideration of harmful effects by Oil & Grease, cleaning agents, etc., on BOD, COD, TSS, and nutrient removal.

Table 6: Design COD, BOD, and TSS Loading

Parameter	Design Flow (m <sup>3</sup> /h)	Design Inlet Water Quality (mg/L)	Design Loading (kg/h)	Safe Loading along with septage addition (80% of Design Load)
COD	27000 m <sup>3</sup> /d x 1 day/24 h = 1125 m <sup>3</sup> /h	COD = 450 mg/L or 0.45 kg/m <sup>3</sup>	1125 m <sup>3</sup> /h x 0.45 kg/m <sup>3</sup> = 506.5 kg/h	0.8 x 506.5 kg/h = 405.2 kg/h
BOD	1125 m <sup>3</sup> /h	BOD = 250 mg/L or 0.25 kg/m <sup>3</sup>	1125 m <sup>3</sup> /h x 0.25 kg/m <sup>3</sup> = 281.3 kg/h	0.8 x 281.3 kg/h = 225 kg/h
TSS	1125 m <sup>3</sup> /h	TSS = 450 mg/L or 0.45 kg/m <sup>3</sup>	1125 m <sup>3</sup> /h x 0.45 kg/m <sup>3</sup> = 506 kg/h	0.8 x 506 kg/h = 405 kg/h

The assumed septage quality characteristics in terms of COD, BOD and TSS is calculated as follows:

Assuming the volume of 1 truck/tanker = 3 m<sup>3</sup>

Therefore, organic loading of 1 truck/tanker

COD loading = 30 kg COD/m<sup>3</sup> x 3 m<sup>3</sup>/truck = 90 kg COD/truck

BOD loading = 20 kg BOD/m<sup>3</sup> x 3 m<sup>3</sup>/truck = 60 kg BOD/truck

TSS loading = 30 kg TSS/m<sup>3</sup> x 3 m<sup>3</sup>/truck = 90 kg TSS/truck

The design, safe and actual COD, BOD, and TSS loading is plotted in figures 7-9.

**Figure 7: Actual COD loading variation, design COD load, and safe design load**

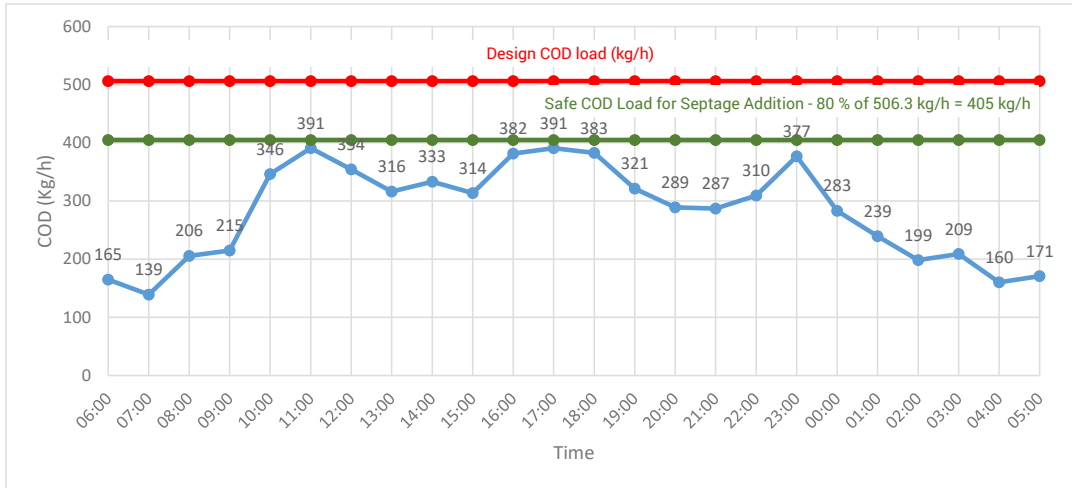

**Figure 8: Actual BOD loading variation, design BOD load, and safe design load**

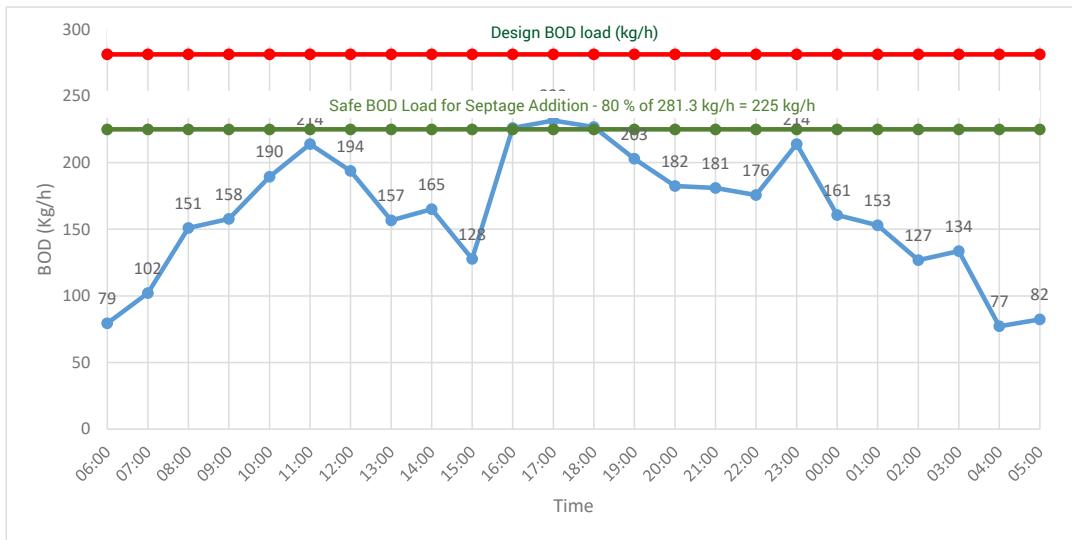

**Figure 9: Actual TSS loading variation, design TSS load, and safe design load**

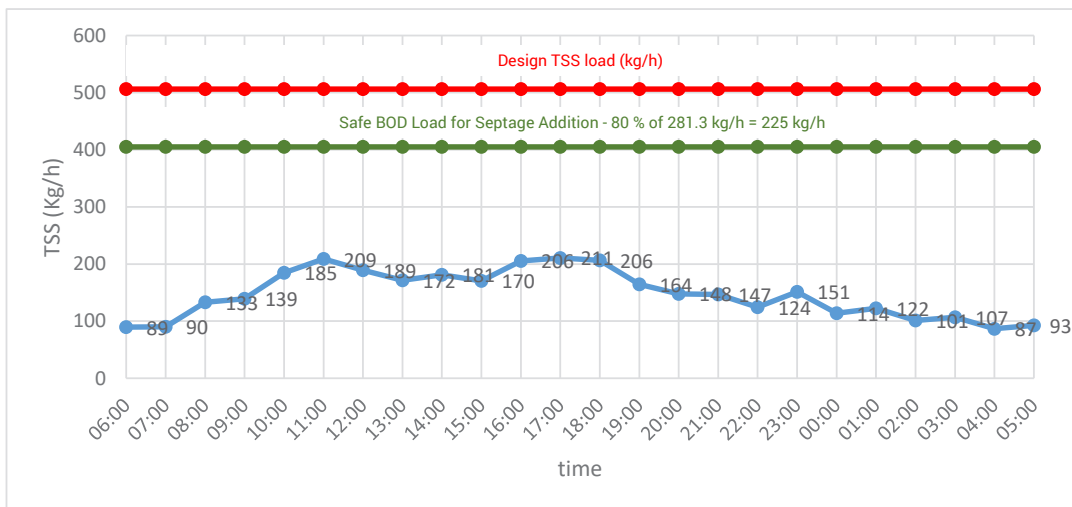

COD, BOD, and TSS loading during working hours (i.e., 10:00 am to 11:00 pm) is quite high; hence septage addition is not recommended between 10:00 am to 11:00 pm . It is possible only after 11:00 pm when the organic and hydraulic loading at the STP reduces. Therefore, a storage facility to hold the septage coming throughout the day is required to carry out co-treatment at the STP. Calculations for COD, BOD and TSS loadings are provided in Table 7.

**Table 7: Loading condition and disposing criteria**

Duration	COD Loading	BOD Loading	TSS Loading
	Safe COD Loading 405 kg/h	Safe BOD Loading 225 kg/h	Safe TSS Loading 405kg/h
	Septage Tanker Load= 90 kg COD/Tanker	Septage Tanker Load= 60 kg BOD/Tanker	Septage Tanker Load= 90 kg TSS/Tanker
Between 11:00 pm– 10:00 am	Average actual COD loading = 225 kg/h	Average actual BOD loading = 135 kg/h	Average actual TSS loading = 117 kg/h
	405 kg/h - 225 kg/h = <b>180 kg COD/h or 2 truck/h can be disposed</b>	225 kg/h - 135 kg/h= <b>90 kg/h or 1.5 truck/h can be disposed</b>	405 kg/h - 117 = <b>288 kg/h or 3 truck/h can be disposed</b>

Therefore, total number of trucks can be disposed = 1.5 trucks x 11= 16.5 trucks  
 Volume of septage that can be disposed = 16.5 trucks x 3 m<sup>3</sup>/truck = 49.5 m<sup>3</sup>

### 3.3. A Case-Study on Strategies of Co-Treatment of Septage at 18 MLD STP, Sarai Haridwar

#### 3.3.1. Introduction

The 18 MLD STP at Sarai is based on the SBR process. It was commissioned in April 2014.

The STP is comprised of receiving chamber, coarse screen (manual and mechanical), raw sewage sump, pump house, stilling chamber, fine screen (manual and mechanical), grit chamber, parshall flume, SBR basin, chlorine contact tank, sludge sump and centrifuge as shown in Figure 10.

### 3.3.2 Flowsheet

The flowsheet of the STP is given in Figure 10.

Figure 10: Flow Diagram of 18 MLD STP at Sarai

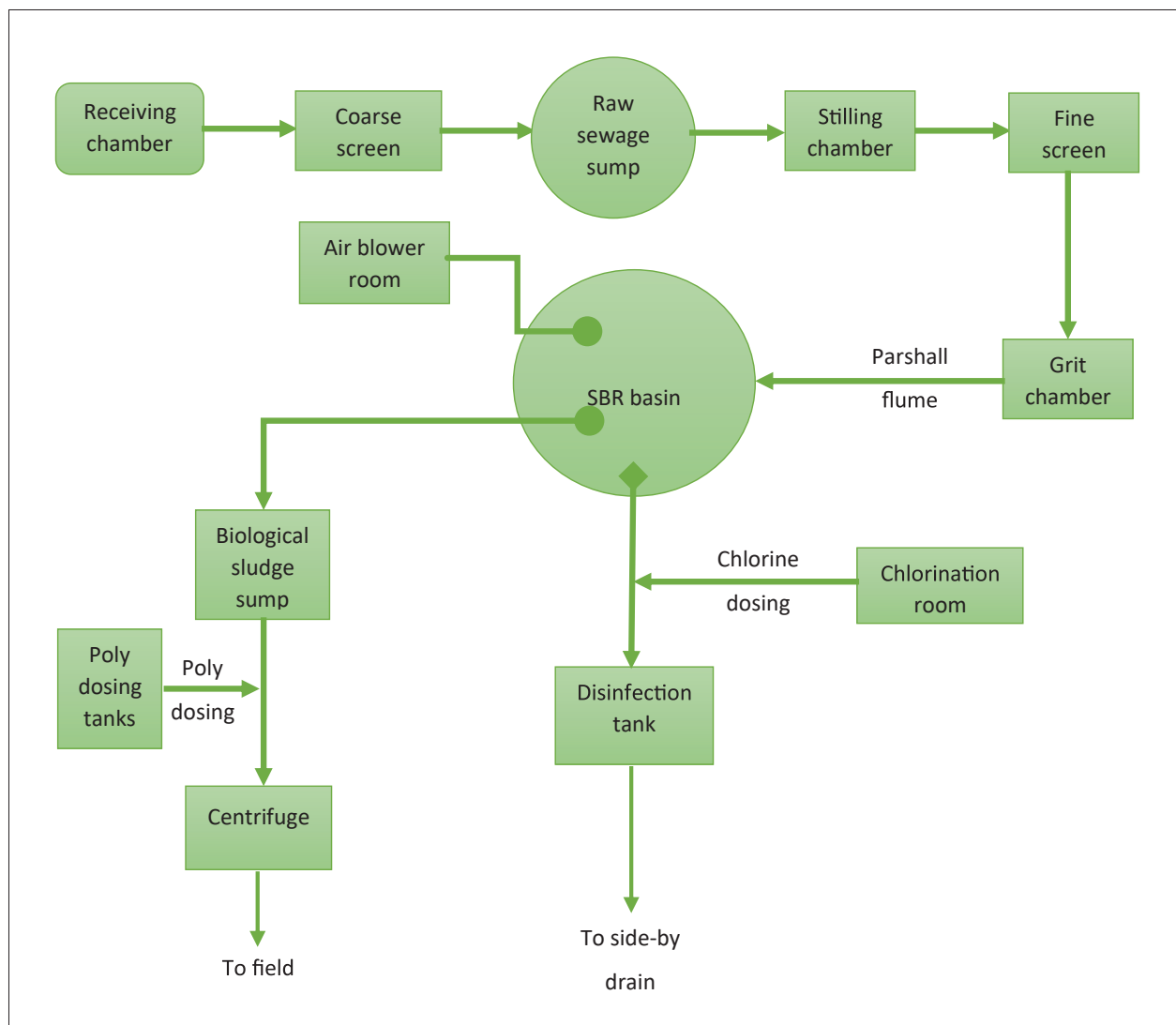

### 3.3.3 design parameters & unit sizes

The STP was designed for an average flow of 18 MLD and a peak flow of 48.6 MLD. The design inlet and outlet water quality parameters are summarized in Table 8. The unit sizes are also summarised in Table 9.

Table 8: Inlet and Outlet water quality parameters

S.No.	Parameter	Units	Influent	Effluent
1.	BOD	mg/L	250	<10
2.	COD	mg/L	450	<50
3.	TSS	mg/L	400	<10
4.	TKN	mg/L	15	<5
5.	NH <sub>4</sub> -N	mg/L	10	<2
6.	T-P	mg/L	5	<2
7.	Fecal coliforms	MPN/100mL	1x10 <sup>6</sup>	nil

**Table 9: Unit sizes of STP**

S.No.	Description	Dimensions	No.
1.	Receiving chamber	13.5 m <sup>2</sup> x 2.5 m SWD	1
2.	Coarse screen (mechanical)	6.0 m x 0.7 m x 0.75 m SWD	2
3.	Coarse screen (manual)	6.0 m x 0.7 m x 0.75 m SWD	1
4.	Raw sewage collection sump	10.5 m dia x 2.5 m SWD	1
5.	Stilling chamber	2.85 m x 4.75 m x 2.5 m SWD	1
6.	Fine screen (mechanical)	6.0 m x 0.65 m x 0.75 m SWD	2
7.	Fine screen (manual)	6.0 m x 0.6 m x 0.75 m SWD	1
8.	Grit chamber- mechanical	5.7 m x 5.7 m x 0.9 m SWD	2
9.	Grit chamber – manual	4.0 m x 8.1 m x 1.1 m SWD	1
10.	Parshall flume	8.0 m long x 0.9 m wide	1
11.	SBR basin	57.0 m dia x 5.0 m SWD	1
12.	Disinfection tank	27.0 m x 9.5 m x 3.0 m SWD	1
13.	Chlorination room	4.2 x 4.85 m x 3.35 m HT	1
14.	Tonner room	7.7 m x 5.05 m x 4.5 m HT	1
15.	Biological sludge sump	6.0 m x 4.9 m x 3.0 m SWD	1
16.	Polyelectrolyte dosing tanks	1.8 m x 1.8 m x 1.0 m SWD	2
17.	Centrifuge house	9.0 m x 5.46 m x 9.3 m HT	
18.	DG room	6.0 m x 10.0 m x 4.5 m HT	
19.	Sludge pump/Blower room	6.0 m x 5.0 m x 4.5 m	

### 3.3.4. Flow and water quality analysis

#### Flow Variation

Flow variation is required for obtaining peak and lean flows. The peak factor is one of the essential criteria for designing the preliminary treatment units and the flexibility of the biological process to handle peak flows. The STP received an average flow of 658 m<sup>3</sup>/h or 15.8 MLD on 6-7<sup>th</sup> June 2019, whereas the peak flow was measured as 1,185 m<sup>3</sup>/h with a peak factor of 1.8, which is lower than the design peak factor. Figure 11 shows the flow variation.

**Figure 11: Variation inflow at STP**

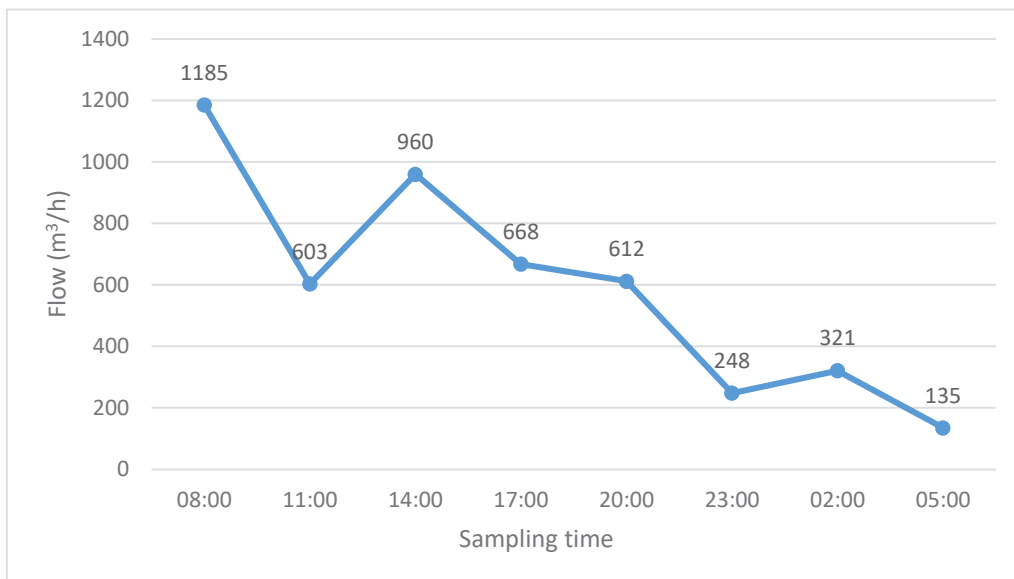



### COD Variation

Figure 12 shows the COD variation in raw sewage and treated effluent. The minimum and maximum COD values in the raw sewage varied from 191 mg/L to 375 mg/L with a composite value of 357 mg/L. The time variable effluent COD concentration is in the range of 30 mg/L to 61 mg/L with a composite value of 40 mg/L.

FIGURE 12: COD variation at STP

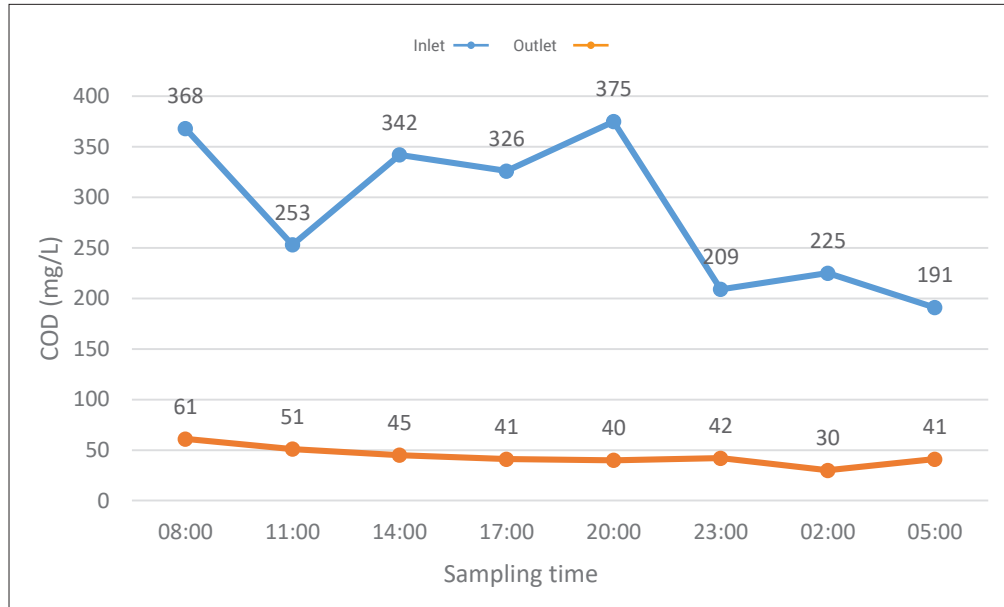

### BOD Variation

Figure 13 shows the BOD variation in raw sewage and treated effluent. The minimum and maximum BOD value in the raw sewage varied from 109 mg/L to 290 mg/L with a composite value of 192 mg/L. The time variable effluent BOD concentration is in the range of 7 mg/L to 13 mg/L with a composite value of 10 mg/L.

Figure 13: BOD variation at STP

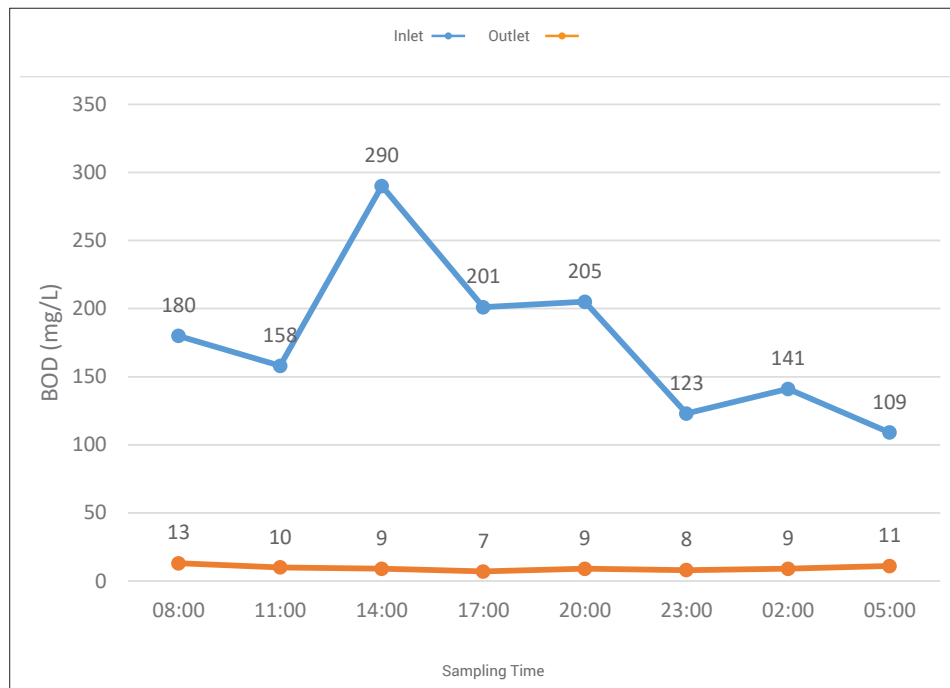

### TSS Variation

Figure 14 shows the TSS variation in raw sewage and treated effluent. The minimum and maximum TSS value in the raw sewage varied from 166 mg/L to 258 mg/L with a composite value of 188 mg/L. The time variable effluent TSS concentration is in the range of 8 mg/L to 15 mg/L with a composite value of 8 mg/L.

Figure 14: TSS variation at STP

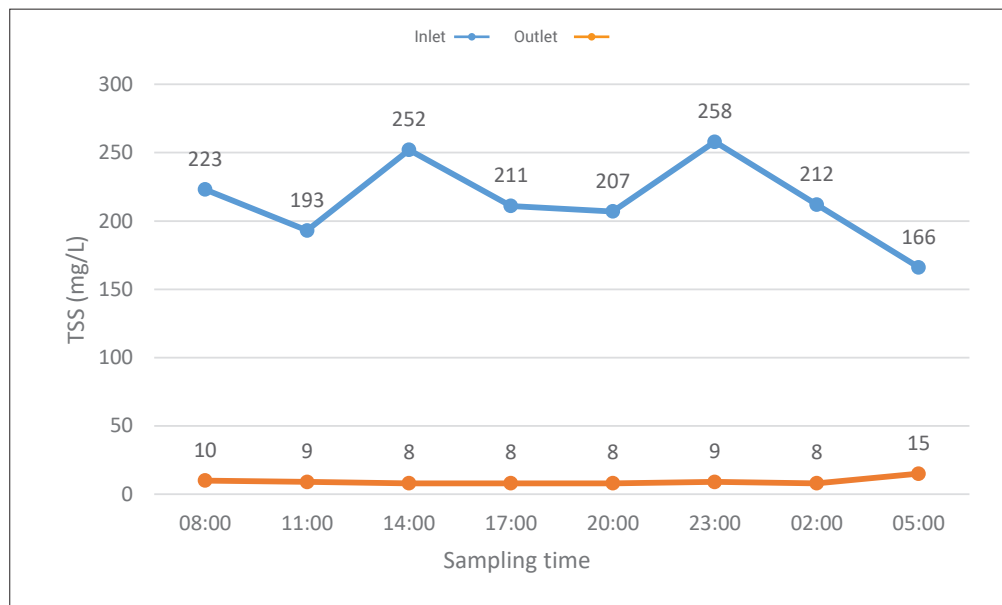

### 3.3.5. Composite sampling & analysis

For composite sampling, representative samples were collected at a regular time interval of 3-h on 6-7<sup>th</sup> June 2019. The flow rate was recorded by pump operation. The representative samples were then integrated by mixing the portions of the individual samples relative to the flowrate at sampling time to make a composite sample. Analyses of alkalinity, COD, BOD, TSS, NH<sub>4</sub>-N, NO<sub>3</sub>-N, and PO<sub>4</sub>-P were carried out as per the Standard Methods (APHA, 2012) and presented in Table 10. The results show that almost all parameters satisfy the design outlet quality.

Table10: Results of Composite Sample

S.No.	Parameters	Unit	Raw sewage	Outlet	Desired Effluent Quality
1	Alkalinity as CaCO <sub>3</sub>	mg/L	290	200	-
2	pH	-	7.4	7.6	-
3	Turbidity	NTU	180	1.8	-
4	BOD	mg/L	192	10	10
5	COD	mg/L	357	40	50
6	TSS	mg/L	188	8	10
7	NH <sub>4</sub> -N	mg/L	26.4	1.3	2
8	NO <sub>3</sub> -N	mg/L	0.2	4.5	-
9	TKN	mg/L	31.5	2.4	5
10	TN	mg/L	31.7	6.9	-
11	PO <sub>4</sub> -P	mg/L	1.6	0.3	-

### 3.3.6. Strategies for septage addition for design and actual cod, bod and tss loadings

The design COD, BOD, and TSS loadings are summarized in the following Table 11. The safe load for septage addition is assumed as 80% of the design load. The safety factor is taken for consideration of harmful effects by Oil & Grease, cleaning agents, etc., on BOD, COD, TSS, and nutrient removal.

Table 11: Design COD, BOD, and TSS Loading

Parameter	Design Flow (m <sup>3</sup> /h)	Design Inlet Water Quality (mg/L)	Design Loading (kg/h)	Safe Loading for co-treatment with septage addition (80% of Design Load)
COD	18000 m <sup>3</sup> /d x 1 day/24 h = 750 m <sup>3</sup> /h	COD = 450 mg/L or 0.45 kg/m <sup>3</sup>	750 m <sup>3</sup> /h x 0.45 kg/m <sup>3</sup> = 337.5 kg/h	0.8 x 337.5 kg/h = 270 kg/h
BOD	750 m <sup>3</sup> /h	BOD = 250 mg/L or 0.25 kg/m <sup>3</sup>	750 m <sup>3</sup> /h x 0.25 kg/m <sup>3</sup> = 187.5 kg/h	0.8 x 187.5 kg/h = 150 kg/h
TSS	750 m <sup>3</sup> /h	TSS = 400 mg/L or 0.4 kg/m <sup>3</sup>	750 m <sup>3</sup> /h x 0.4 kg/m <sup>3</sup> = 300 kg/h	0.8 x 300 kg/h = 240 kg/h

The assumed septage tanker loading in terms of COD, BOD and TSS is calculated as follows:

Assuming the volume of 1 truck/tanker = 3 m<sup>3</sup>

Therefore, organic loading of 1 truck/tanker

COD loading = 30 kg COD/m<sup>3</sup> x 3 m<sup>3</sup>/truck = 90 kg COD/truck

BOD loading = 20 kg BOD/m<sup>3</sup> x 3 m<sup>3</sup>/truck = 60 kg BOD/truck

TSS loading = 30 kg TSS/m<sup>3</sup> x 3 m<sup>3</sup>/truck = 90 kg TSS/truck

The design, safe and actual COD, BOD, and TSS loading is plotted in figures 15-17.

Figure 15: Actual COD loading variation, Design COD load, and safe design load

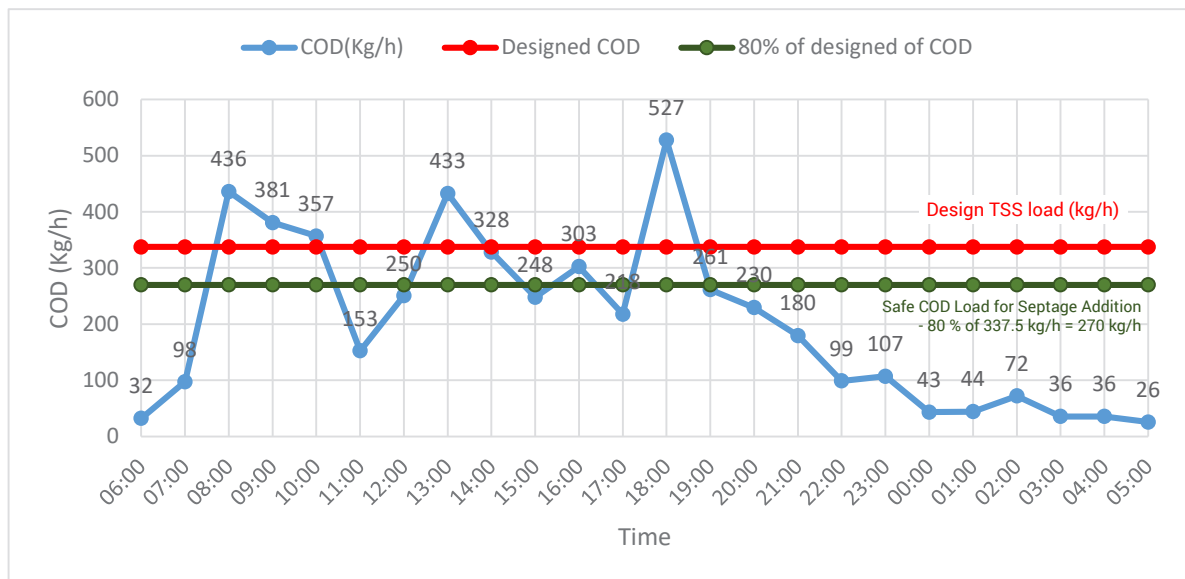

**Figure 16: Actual BOD loading variation, Design BOD load, and safe design load**

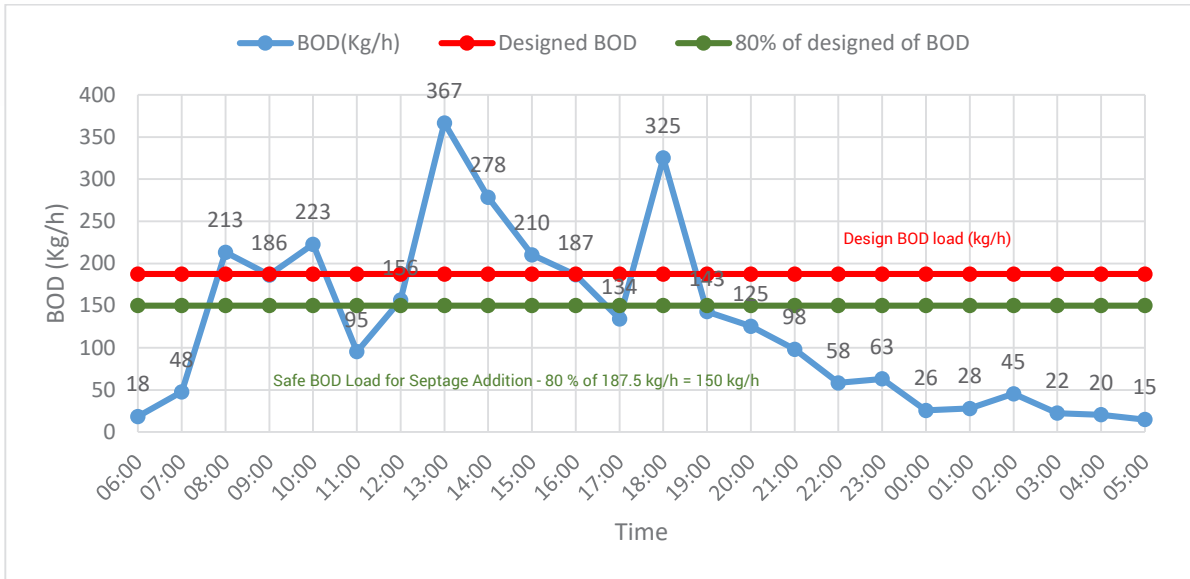

**Figure 17: Actual TSS loading variation, Design TSS load, and safe design load**

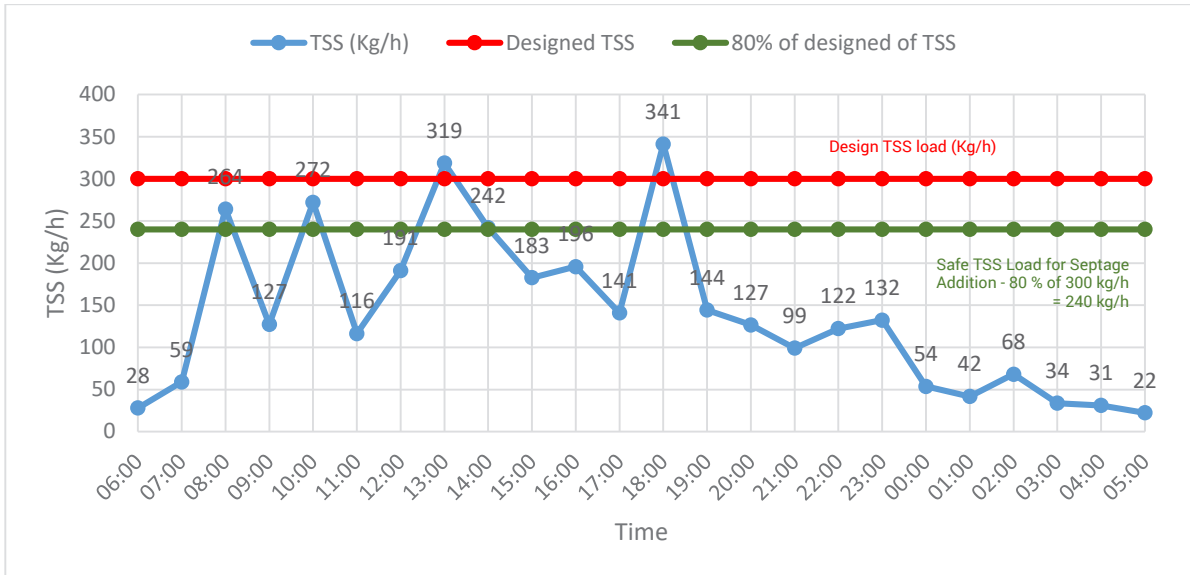

Actual COD, BOD, and TSS loading during working hours (i.e., 8:00 am to 7 pm) is high. Therefore, during this duration, co-treatment is not possible. To achieve co-treatment at the STP, the septage should be added after 7:00 pm; a septage storage facility is required in order to achieve this.

Assuming the volume of 1 truck/tanker = 3 m<sup>3</sup>

Therefore, organic loading of 1 truck/tanker

$$\text{COD loading} = 30000 \text{ mg/L} \times 3 \text{ m}^3 / \text{truck} = 90 \text{ Kg/truck}$$

$$\text{BOD loading} = 20000 \text{ mg/L} \times 3 \text{ m}^3 / \text{truck} = 60 \text{ Kg/truck}$$

$$\text{TSS loading} = 30000 \text{ mg/L} \times 3 \text{ m}^3 / \text{truck} = 90 \text{ Kg/truck}$$

**Table 12: Loading Condition and Disposing Criteria**

Duration	Considering COD	Considering BOD	Considering TSS
	Safe COD loading = 270 kg/h	Safe BOD loading = 150 kg/h	Safe TSS loading = 240kg/h
	Septage Tanker Load= 90 kg COD/Tanker	Septage Tanker Load= 60 kg BOD/Tanker	Septage Tanker Load= 90 kg TSS/Tanker
Between 7:00 pm to 7 :00 am	Average actual COD loading = 97 kg/h	Average actual BOD loading = 54 kg/h	Average actual TSS loading = 74 kg/h
	<b>270 kg/h – 97 kg/h = 173 kg/h or 2 truck/h can be disposed</b>	<b>150 kg/h -54 kg/h = 96 kg/h or 1.5 truck/h can be disposed</b>	<b>240 kg/h -74 kg/h = 196 kg/h or 2 truck/h can be disposed</b>

Therefore, total no of trucks can be disposed = 12 x 1.5 truck = 18 trucks  
 Volume of septage that can be disposed = 18 trucks x 3 m<sup>3</sup>/truck = 54 m<sup>3</sup>

### 3.4.A Case-Study On Strategies of Co-Treatment of Septage at 18 MLD STP, Kankhal Haridwar

#### 3.4.1. Introduction

The 18 MLD STP at Kankhal, Haridwar was constructed and commissioned by U.P. Jal Nigam in 1990. It is based on the conventional Activated Sludge Process (ASP). STP is comprised of stilling chamber, fine screen (manual and mechanical), grit chamber, parshall flume, primary clarifiers, aeration tanks, secondary settling tanks, sludge thickener, anaerobic sludge digesters, and sludge drying beds.

#### 3.4.2. Flowsheet

The flowsheet of the STP is given in Figure 18

**Figure 18: Flowsheet of 18 MLD STP**

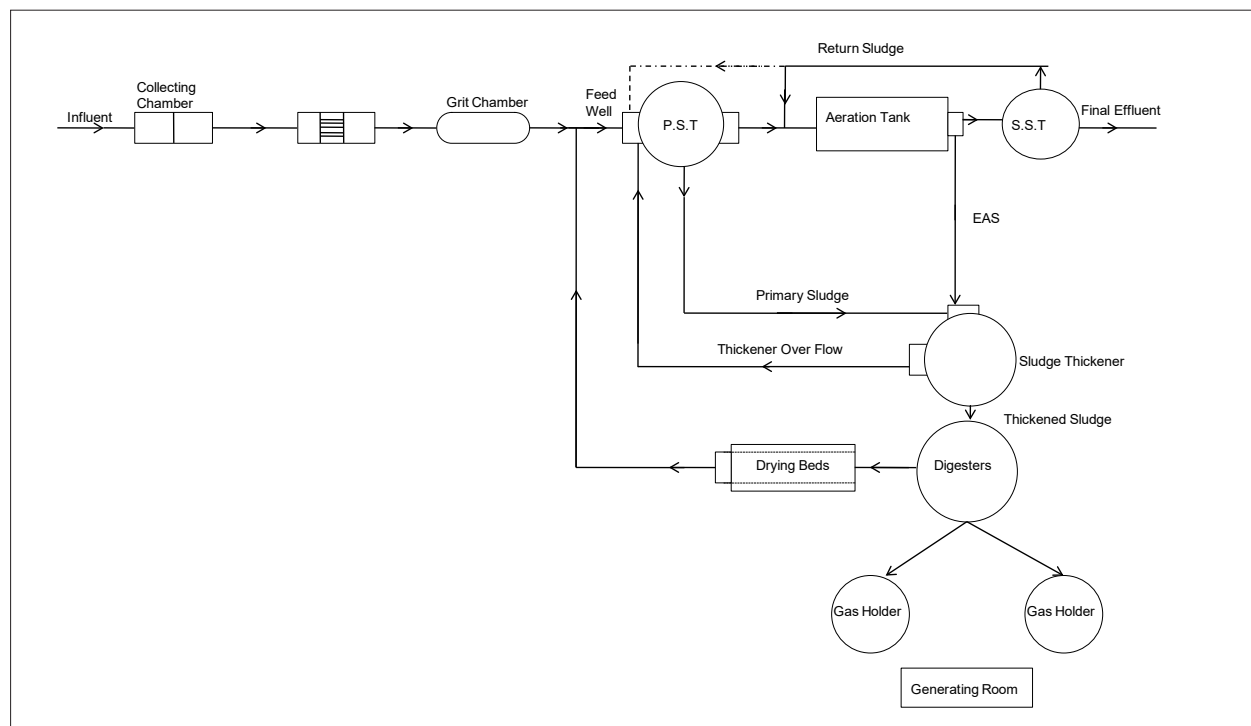

### 3.4.3. Design parameters & unit sizes

The STP is designed for an average flow of 18 MLD and a peak flow of 40.5 MLD. The design inlet and outlet water quality parameters are summarized in Table 13. The unit sizes are summarised in Table 14.

**Table13: Inlet and Outlet Water Quality Parameters**

S.No.	Parameter	Units	Influent	Effluent
1.	BOD	mg/L	300	<20
3.	TSS	mg/L	600	<30

**Table14: Unit Sizes of STP**

S. No.	Description	Dimensions	No.
1.	Screen Chamber	Width – 600mm Depth of water -275 mm Capacity – 18 MLD	3
2.	Grit Chamber	3.8m × 3.8 m ×1.25 m	3
3.	Primary Sedimentation Tank	Diameter -15 m Depth -3 m	3
4.	Aeration Tank	Area- 15 m × 15 m Depth – 5.2 m	3
5.	SST	Diameter -19.5 m Depth – 3.5 m	3
6.	Sludge Thickener	Diameter -11.4 m Depth – 3 m Capacity -528 m <sup>3</sup> /day	2
7.	Sludge Digester	Diameter -18 m Capacity-132 m <sup>3</sup> /day	2
8.	Gas collector	Capacity-920 m <sup>3</sup> /day	2
9.	Sludge Drying Beds	Area - 35 m × 24 m Depth – 0.25 m	12

### 3.4.4. Flow and water quality analysis

#### Flow Variation

Flow variation is needed for obtaining peak and lean flows. The peak factor is one of the essential criteria for the design of preliminary treatment units and the flexibility of the biological process to handle peak flows. The average flow at the STP was 795 m<sup>3</sup>/h or 19.1 MLD on 6-7<sup>th</sup> June 2019, and the peak flow was measured as 897 m<sup>3</sup>/h with a peak factor of 1.13, which is lower than the design peak factor. Figure 19 shows the flow variation.

**Figure 19: Variation of inflow at STP**

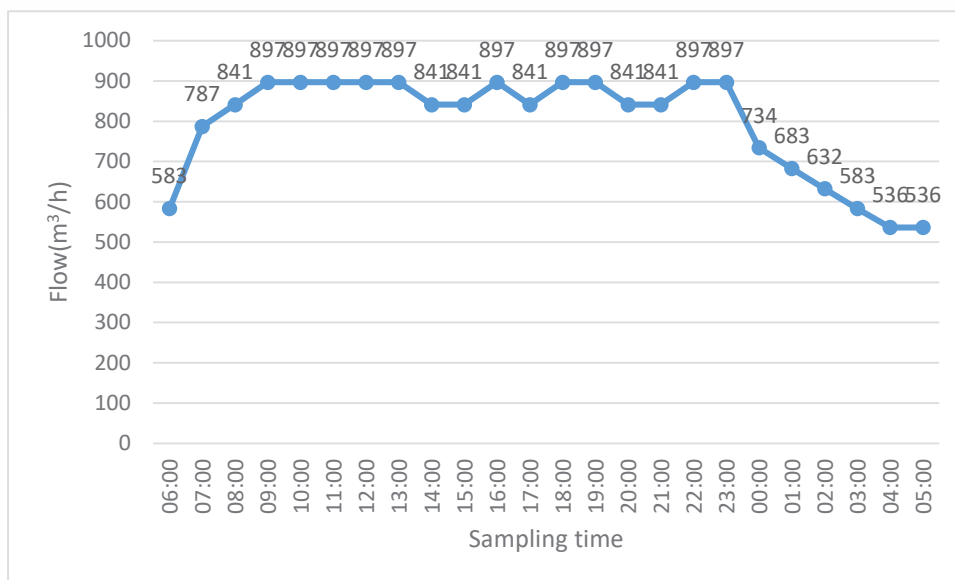

**COD Variation**

Figure 20 shows the COD variation in raw sewage, primary clarifier effluent, and treated effluent. The minimum and maximum COD values in raw sewage varied from 212 mg/L to 376 mg/L with a composite value of 305 mg/L. The time variable effluent COD concentration is in the range of 21 mg/L to 41 mg/L with a composite value of 29 mg/L.

**Figure 20: COD variation at STP**

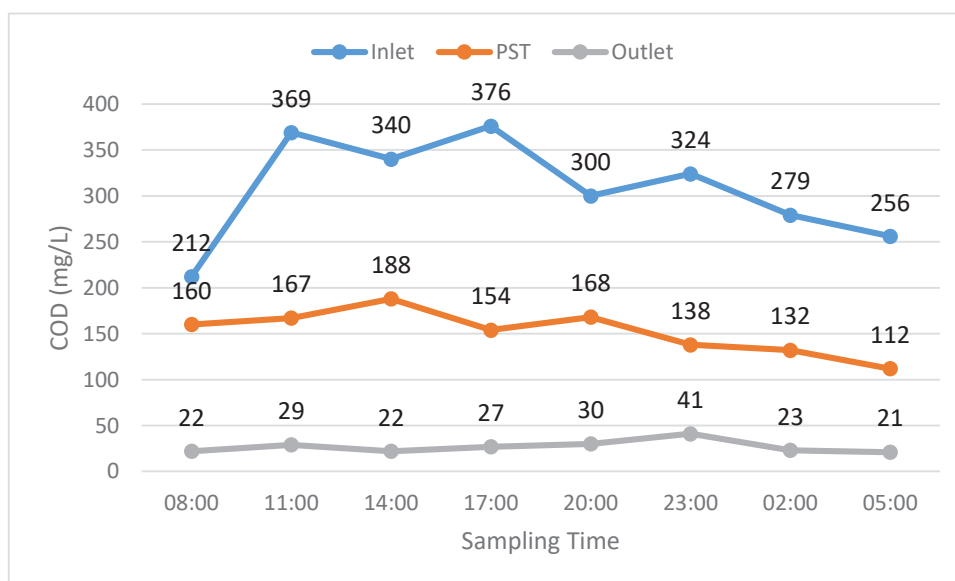

**BOD Variation**

Figure 21 shows the BOD variation in raw sewage, primary clarifier effluent, and treated effluent. The minimum and maximum BOD values in raw sewage varied from 141 mg/L to 231 mg/L with a composite value of 182 mg/L. The time variable effluent BOD concentration is in the range of 7 mg/L to 12 mg/L with a composite value of 10 mg/L.

Figure 21: BOD variation at STP

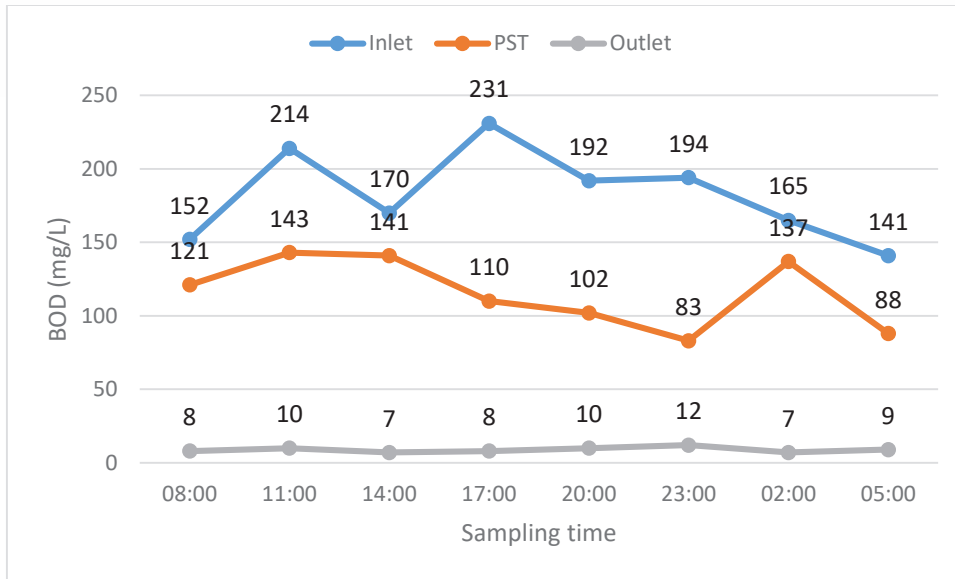

### TSS Variation

Figure 22 shows the TSS variation in raw sewage and treated effluent. The minimum and maximum TSS values in raw sewage varied from 136 mg/L to 198 mg/L with a composite value of 157 mg/L. The time variable effluent TSS concentration is in the range of 5 mg/L to 8 mg/L with a composite value of 6 mg/L.

Figure 22: TSS variation at STP

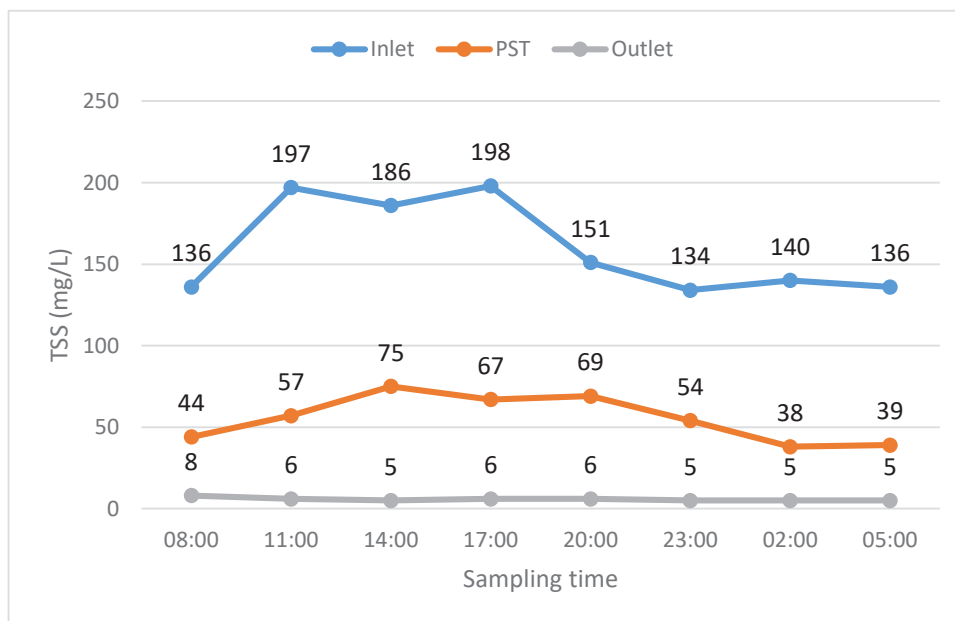

### 3.4.5. Composite sampling & analysis

For composite sampling, representative samples were collected at the regular time interval of 3-h on 6-7th June 2019. The flow rate was recorded by pump operation. The representative samples were then integrated by mixing together the portions of the individual samples relative to the flowrate at sampling time to make a composite sample. Analyses of alkalinity, COD, BOD, TSS, NH<sub>4</sub>-N, NO<sub>3</sub>-N, and PO<sub>4</sub>-P were carried out as per the Standard Methods (APHA, 2012) and presented in Table 15. The results show that almost all parameters satisfy the design outlet quality.



**Table 15: Results of Composite Sample**

S.No.	Parameters	Unit	Raw sewage	PST effluent	Outlet	Desired Effluent Quality
1	Alkalinity as CaCO <sub>3</sub>	mg/L	310	300	240	-
2	pH		7.5	7.4	7.7	-
3	Turbidity	NTU	89	59	1.5	-
4	COD	mg/L	305	138	29	-
5	BOD	mg/L	182	89	10	20
6	TSS	mg/L	157	50	6	30
7	NH <sub>4</sub> -N	mg/L	23	22.4	1.3	-
8	NO <sub>3</sub> -N	mg/L	0.2	0.3	4.8	-
9	TN	mg/L	26.9	26	3.2	-
10	PO <sub>4</sub> -P	mg/L	2	1.8	0.8	-

### 3.4.6. Strategies for septage addition for design and actual COD, BOD and TSS loadings

The design COD, BOD, and TSS loadings are summarized in Table 16. The safe load for septage addition is assumed as 80% of the design load. The safety factor is taken for consideration of harmful effects by Oil & Grease, cleaning agents, etc., on BOD, COD, TSS, and nutrient removal.

**Table 16: Design COD, BOD, and TSS Loading**

Parameter	Design Flow (m <sup>3</sup> /h)	Design Inlet Water Quality (mg/L)	Design Loading (kg/h)	Safe Loading for co-treatment with septage addition (80 % of Design Load)
BOD	750 m <sup>3</sup> /h	BOD = 300 mg/L or 0.3 kg/m <sup>3</sup>	750 m <sup>3</sup> /h x 0.3 kg/m <sup>3</sup> = 225 kg/h	0.8 x 225 kg/h = 180 kg/h
TSS	750 m <sup>3</sup> /h	TSS = 600 mg/L or 0.6 kg/m <sup>3</sup>	750 m <sup>3</sup> /h x 0.6 kg/m <sup>3</sup> = 450 kg/h	0.8 x 450 kg/h = 360 kg/h

The assumed septage tanker loading in terms of COD, BOD and TSS is calculated as follows:

Assuming the volume of 1 truck/tanker = 3 m<sup>3</sup>

Therefore, organic loading of 1 truck/tanker

$$\text{COD loading} = 30 \text{ kg COD/m}^3 \times 3 \text{ m}^3/\text{truck} = 90 \text{ kg COD/truck}$$

$$\text{BOD loading} = 20 \text{ kg BOD/m}^3 \times 3 \text{ m}^3/\text{truck} = 60 \text{ kg BOD/truck}$$

$$\text{TSS loading} = 30 \text{ kg TSS/m}^3 \times 3 \text{ m}^3/\text{truck} = 90 \text{ kg TSS/truck}$$

The design, safe and actual COD, BOD, and TSS loading is plotted in figures 23-25

**Figure 23: Actual BOD loading variation, Design BOD load, and safe design load**

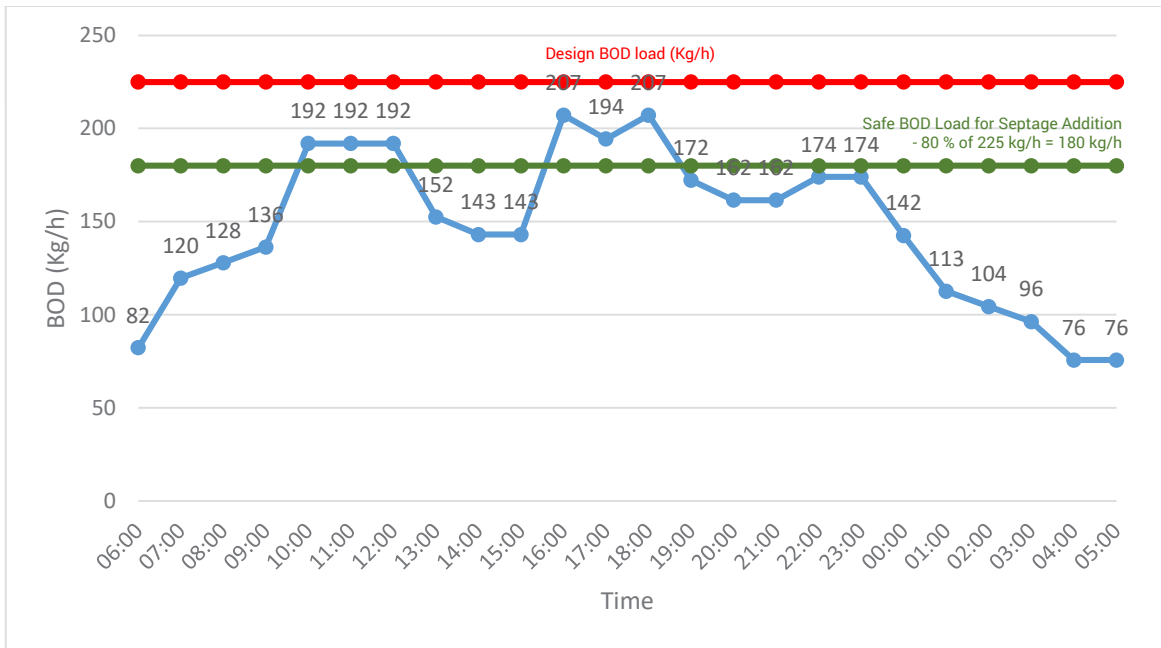

**Figure 24: Actual TSS loading variation, Design TSS load, and safe design load**

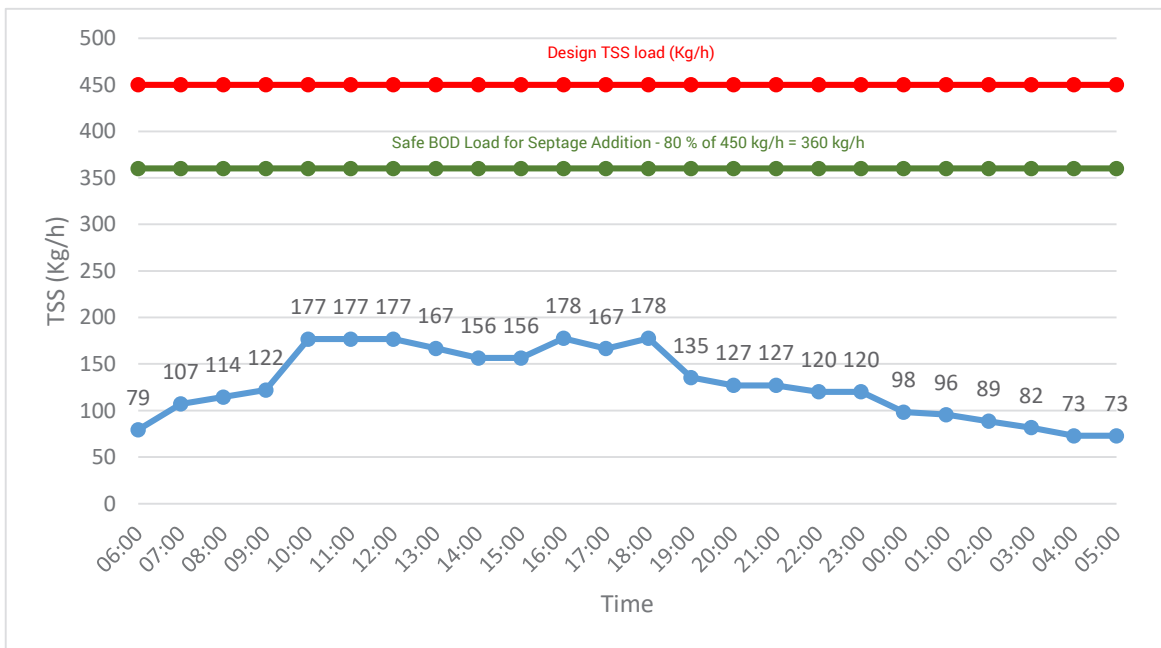

Actual COD, BOD, and TSS loading during working hours (i.e., 9:00 am to 11:00 pm) was higher than the design loading. Therefore, during this duration, co-treatment is not possible. To achieve co-treatment at the STP, the septage should be added after 11:00 pm; a septage storage facility is required in order to achieve this.

Assuming the volume of 1 truck/tanker = 3 m<sup>3</sup>

Therefore, organic loading of 1 truck/tanker

$$\text{COD loading} = 30000 \text{ mg/L} \times 3 \text{ m}^3 / \text{truck} = 90 \text{ Kg/truck}$$

$$\text{BOD loading} = 20000 \text{ mg/L} \times 3 \text{ m}^3 / \text{truck} = 60 \text{ Kg/truck}$$

$$\text{TSS loading} = 30000 \text{ mg/L} \times 3 \text{ m}^3 / \text{truck} = 90 \text{ Kg/truck}$$

From 10:00 am to 11:00 pm, STP works at its full capacity for BOD oxidation, therefore, additional storage facility is required.

**Table 17: Loading condition and disposing criteria**

Duration	Considering BOD	Considering TSS
	Safe BOD loading = 180 kg/h	Safe TSS loading = 360 kg/h
	Septage Tanker Load= 60 kg BOD/Tanker	Septage Tanker Load= 90 kg TSS/Tanker
Between 11:00 pm – 9:00 am	Average actual BOD loading = 113 kg/h	Average actual TSS loading = 95 kg/h
	180 kg/h -113 kg/h = 57 kg/h or 1 truck/h can be disposed	360 kg/h -95 kg/h = 265 kg/h or 3 trucks/h can be disposed

Therefore, total no of trucks can be disposed = 1 truck x 10 = 10 trucks

Volume of septage that can be disposed = 10 x 3 = 30 m<sup>3</sup>

### 3.5. A Case-Study On Strategies of Co-Treatment Of Septageat 20 MLD, Mothorowala Dehradun

#### 3.5.1.Introduction

The 20 MLD STP at Mothorowala, Dehradun was commissioned in September 2018. It is based on the SBR process and comprises of the Inlet chamber, coarse screens, sump well, pumps, inlet chamber of STP, fine screens, grit chamber, SBR basin, and chlorination tank. The settled sludge from SBR is transferred to excess sludge sump by surplus activated sludge pumps. The excess sludge is then pumped along with poly-electrolyte to centrifuge decanter for dewatering. The dewatered sludge is disposed of in agricultural fields.

#### 3.5.2.Flowsheet

The typical flowsheet of STP is provided in Figure 25.

**Figure 25: Flowsheet of 20 MLD STP**

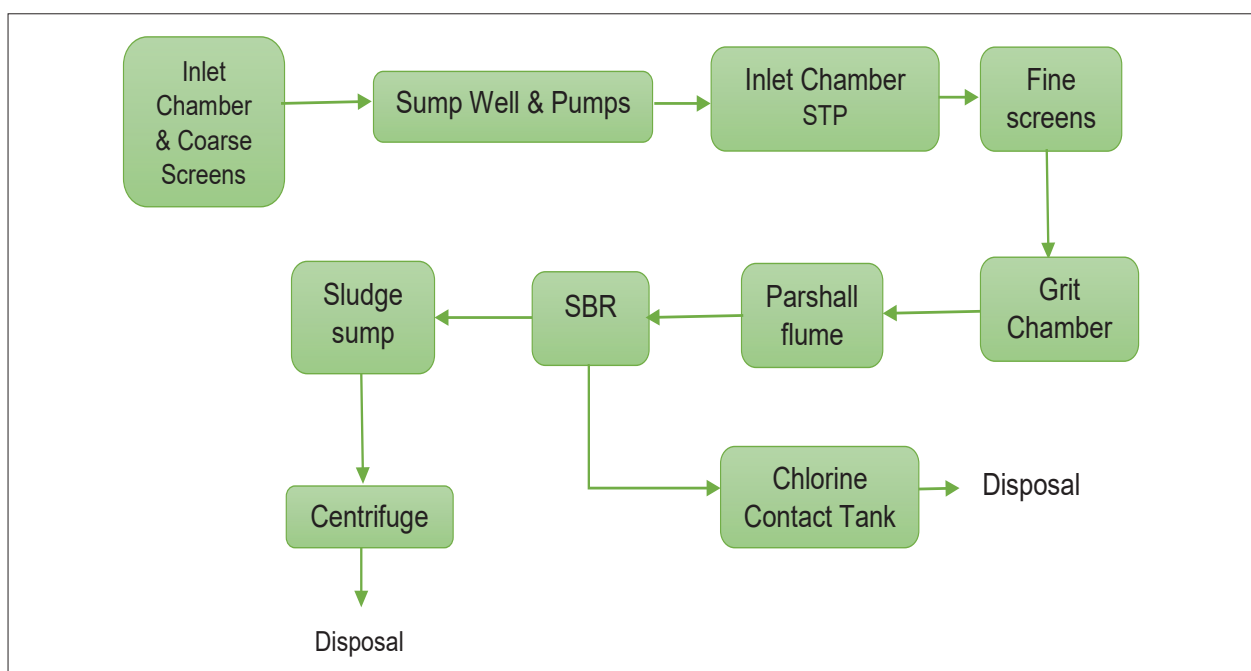

### 3.5.3. Design parameters & unit sizes

The STP is designed for an average flow of 20 MLD and a peak flow of 45 MLD. The design inlet and outlet water quality parameters are summarized in Table 18. The unit sizes are summarised in Table 19.

**Table 18: Inlet and Outlet Water Quality Parameters**

S.No.	Parameter	Units	Influent	Effluent
1.	pH	-	6.0-8.0	6.5-8.8
2.	BOD	mg/L	250	<10
3.	COD	mg/L	450	<100
4.	TSS	mg/L	400	<10
5.	TKN	mg/L	45	< 10 as TN
6.	NH <sub>4</sub> -N	mg/L	8	<2
7.	PO <sub>4</sub> -P	mg/L	5	<2
8.	Fecal Coliforms	MPN/100 ml	10 <sup>6</sup>	230
9.	Total Coliforms	MPN/100 ml	10 <sup>7</sup>	-

**Table 19: Unit Sizes of STP**

S.No	Description	Dimensions	No.
1	Inlet Chamber-MPS	3.8 m x 2.75 m x 1.5 m LD	1
2	Coarse Screen (Mech.) MPS	6.0 m x 1.25 m x 0.75 m LD	1
3	Coarse Screen (Manual) MPS	6.0 m x 1.25 m x 0.75 m LD	1
4	Wet Well	10.7 m Dia x 1.75 m LD	1
5	Valve chamber cum pipe gallery	9.23 m Long x 6.4 m Wide	1
6	Inlet Chamber-STP	3.2 m x 2.45 m x 2.0 m LD	1
7	Fine Bar Screen (Mechanical)	6.0 m x 1.5 m x 0.5 m LD	1
8	Fine Bar Screen (Manual)	6.0 m x 1.5 m x 0.5 m LD	1
9	Grit Chamber	6.85 m x 6.85 m x 1.0 m LD	1
10	Parshall Flume	7.5 m Long x 1.0 m Wide	1
11	Distribution Chamber for SBR	26.57 m long x 1.4 m wide x 1.5 m LD	1
12	SBR	55.0 m Dia x 5.0 m LD	2
13	Chlorine Contact Tank for 20 MLD Flow	26.1 m long x 10.0 m wide x 2.4 m LD	1
14	Chlorinator Room	3.8 m x 5.9 m x 3.5 m HT.	1
15	Chlorine Tonner Room	5.0 m x 5.0 m	1
16	Sludge Sump	8.75 m x 3.4 m x 2.65 m LD	1
17	Centrifuge building	7.85 m x 6.9 m	1
18	Tube Well Pump House	3.0 m x 3.0 m x 4 m HT	1
19	Diesel Generator Room for STP	8.5 m x 5.0 m x 5.5 m HT	1
26	Laboratory, MEP Room, SCADA Room Building Office Building	23.0 m x 8.6 m (G + 1)	1
27	Ground Floor Area: Air Blower Room Operator's Room, Workshop, Toilet	29.3 m x 8.8 m x 6.0 m HT	1
28	HT Panel Room	12.0 x 4.0	1

### 3.5.4 flow and water quality analysis

#### Flow Variation

Flow variation is needed for obtaining peak and lean flows. The peak factor is one of the essential criteria for the design of preliminary treatment units and the flexibility of the biological process to handle peak flows. The observed average flow was 399 m<sup>3</sup>/h or 9.54 MLD, and peak flow was 994 m<sup>3</sup>/h with a peak factor of 2.49 on 16-17<sup>th</sup> June 2019, which is higher than the design peak factor. Figure 26 shows the flow variation throughout the day and night.

Figure 26: Variation of inflow at STP

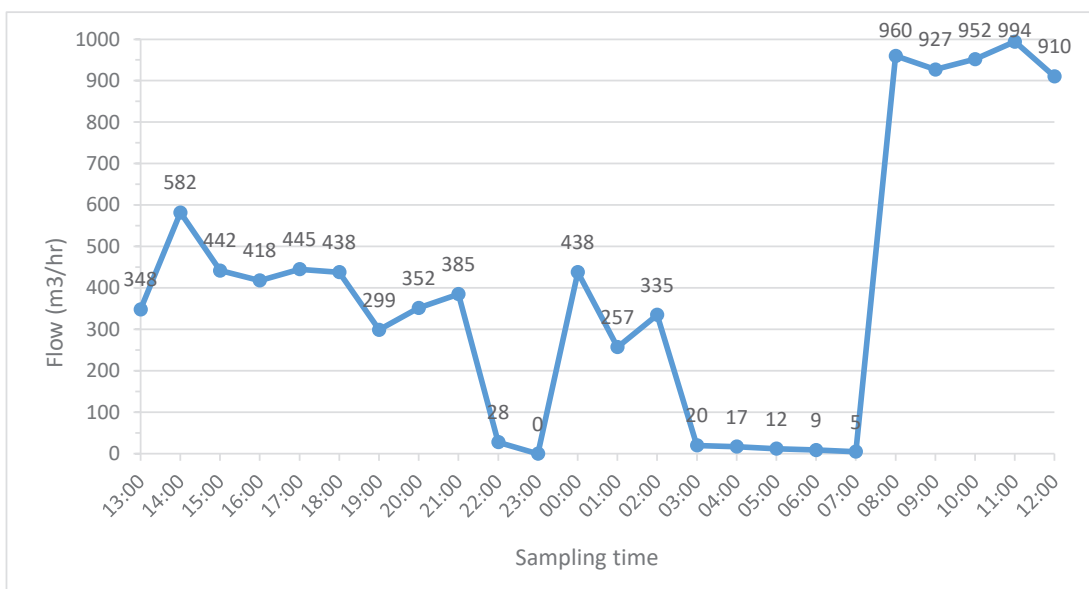

#### COD Variation

Figure 27 shows the COD variation in raw sewage and treated effluent. The minimum and maximum COD in the raw sewage varied from 139 mg/L to 309 mg/L with a composite value of 233 mg/L. The time variable effluent COD concentration is in the range of 25 mg/L to 29 mg/L with a composite value of 27 mg/L.

Figure 27: COD variation at STP

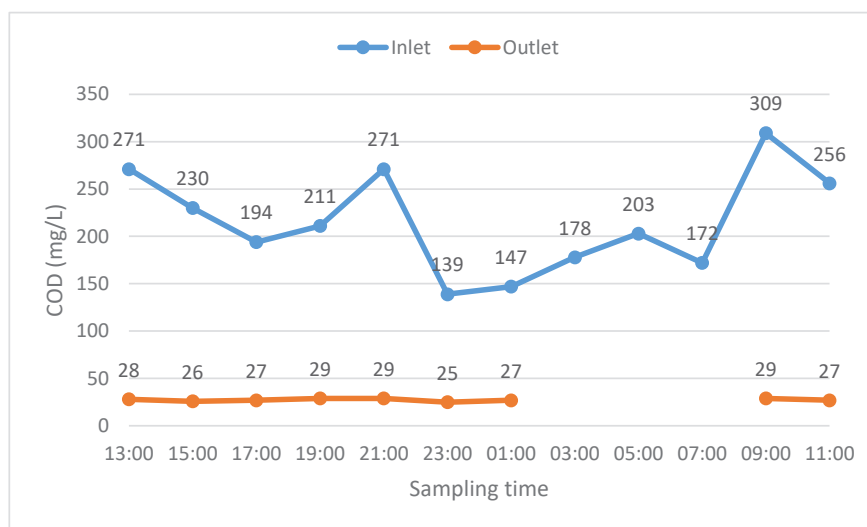

### BOD Variation

Figure 28 shows the BOD variation in raw sewage and treated effluent. The minimum and maximum BOD in the raw sewage varied from 74 mg/L to 146 mg/L with a composite value of 117 mg/L. The time variable effluent BOD concentration is in the range of 6 mg/L to 9 mg/L with a composite value of 7 mg/L. The overall BOD removal efficiency of the system was 92%.

Figure 28: BOD variation at STP

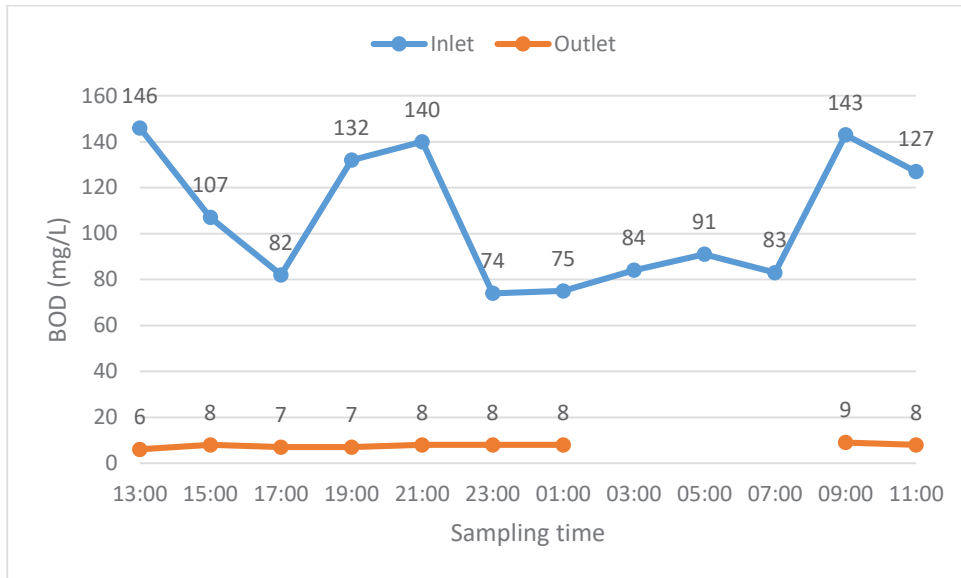

### TSS Variation

Figure 29 shows the TSS variation in raw sewage and treated effluent. The minimum and maximum TSS in the raw sewage varied from 176 mg/L to 247 mg/L with a composite value of 207 mg/L. The time variable effluent TSS concentration is in the range of 6 mg/L to 8 mg/L with a composite value of 7 mg/L. The overall TSS removal efficiency of the system was 96.6%. The high removal of SS in SBR attributed to bio-oxidation during aeration and quiescent settling during the settling phase in each cycle of SBR. The effluent is clear with the turbidity value of 2.5 NTU.

Figure 29: TSS variation at STP

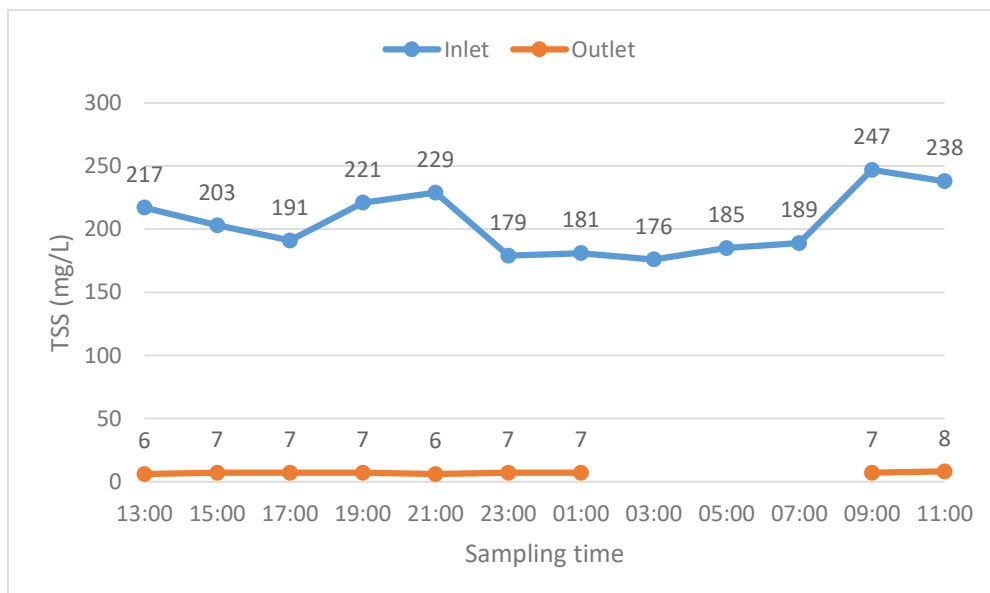

### 3.5.5. Composite sampling and analysis

For composite sampling, representative samples were collected on a regular time interval of 2-h on 16-17<sup>th</sup> June 2019. The flow rate was recorded by pump operation. The representative samples were then integrated by mixing together the portions of the individual samples relative to the flowrate at sampling time to make a composite sample. Analyses of alkalinity, COD, BOD, TSS, NH<sub>4</sub>-N, NO<sub>3</sub>-N, PO<sub>4</sub>-P and Coliforms were carried out as per the Standard Methods (APHA, 2012) and presented in Table 20.

Table 20: Results of Composite Sample

S.No.	Parameters	Unit	Raw sewage	Outlet	Efficiency	Desired Effluent Quality
1	Alkalinity as CaCO <sub>3</sub>	mg/L	400	280	30%	-
2	pH		7.8	7.3		6.5-8.5
3	Turbidity	NTU	80	2.5		-
4	BOD	mg/L	117	7	92.3%	<10
5	COD	mg/L	233	27	87.6%	<100
6	TSS	mg/L	207	7.0	96.6%	<10
7	NH <sub>4</sub> -N	mg/L	45.3	1.0.	97.8%	<2
8	NO <sub>3</sub> -N	mg/L	0.1	4.1	-	-
9	TN	mg/L	48.6	7.2	85%	<10
10	PO <sub>4</sub> -P	mg/L	3.5	3.1	11.4%	-
11	TP	mg/L	4.8	3.7		<2
12	TC	MPN/100ml	2.3 x 10 <sup>7</sup>	4300	4 log	-
14	FC	MPN/100ml	4.3 x 10 <sup>5</sup>	230	3 log	230

### 3.5.6 Strategies for septage addition for design and actual COD, BOD and TSS loadings

The design COD, BOD, and TSS loadings are summarized in the following Table 21. The safe load for septage addition is assumed as 80% of the design load. The safety factor is taken for consideration of harmful effects by Oil & Grease, cleaning agents, etc., on BOD, COD, TSS, and nutrient removal.

Table 21: Design COD, BOD, and TSS Loading

Parameter	Design Flow (m <sup>3</sup> /h)	Design Inlet Water Quality (mg/L)	Design Loading (kg/h)	Safe Loading for co-treatment with septage addition (80 % of Design Load)
COD	20000 m <sup>3</sup> /d x 1 day/24 h = 833 m <sup>3</sup> /h	COD = 450 mg/L or 0.45 kg/m <sup>3</sup>	833 m <sup>3</sup> /h x 0.45 kg/m <sup>3</sup> = 374.8 kg/h	0.8 x 374.8 kg/h = 300 kg/h
BOD	833 m <sup>3</sup> /h	BOD = 250 mg/L or 0.25 kg/m <sup>3</sup>	833 m <sup>3</sup> /h x 0.25 kg/m <sup>3</sup> = 208 kg/h	0.8 x 208 kg/h = 167 kg/h
TSS	833 m <sup>3</sup> /h	TSS = 400 mg/L or 0.45 kg/m <sup>3</sup>	833 m <sup>3</sup> /h x 0.4 kg/m <sup>3</sup> = 333 kg/h	0.8 x 333 kg/h = 267 kg/h

The assumed septage tanker loading in terms of COD, BOD and TSS is calculated as follows:

Assuming the volume of 1 truck/tanker = 3 m<sup>3</sup>

Therefore, organic loading of 1 truck/tanker

$$\text{COD loading} = 30000 \text{ mg/L} \times 3 \text{ m}^3/1000 = 90 \text{ kg COD/truck}$$

BOD loading =  $20000 \text{ mg/L} \times 3 \text{ m}^3 / 1000 = 60 \text{ kg COD/truck}$   
 TSS loading =  $30000 \text{ mg/L} \times 3 \text{ m}^3 / 1000 = 90 \text{ kg COD/truck}$

The design, safe and actual COD, BOD, and TSS loading is plotted in figures 30-32.

**Figure 30: Actual COD loading variation, Design COD load, and safe design load**

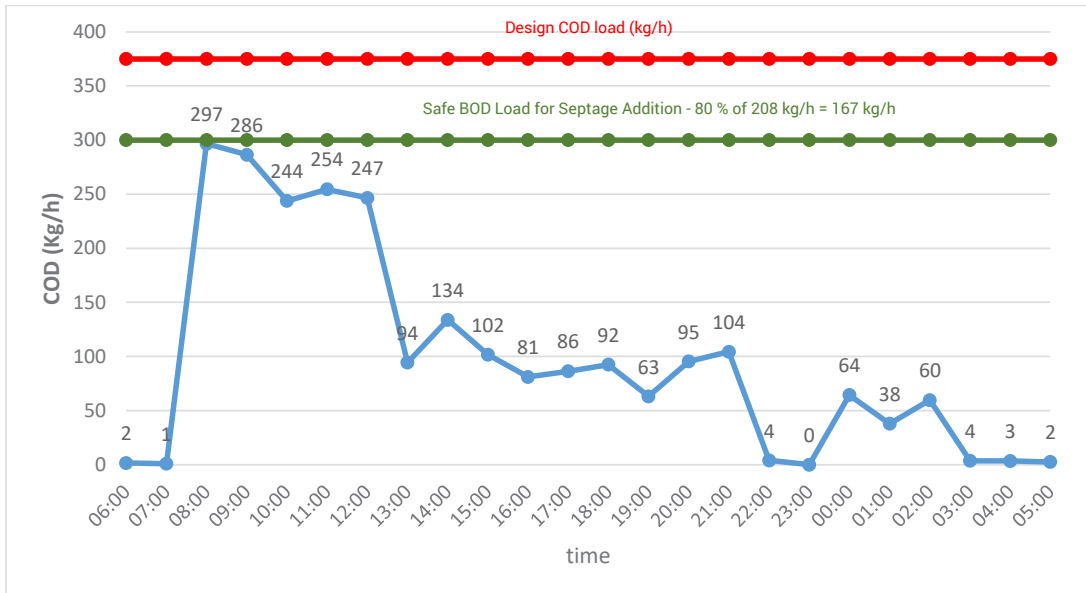

**Figure 31: Actual BOD loading variation, Design BOD load, and safe design load**

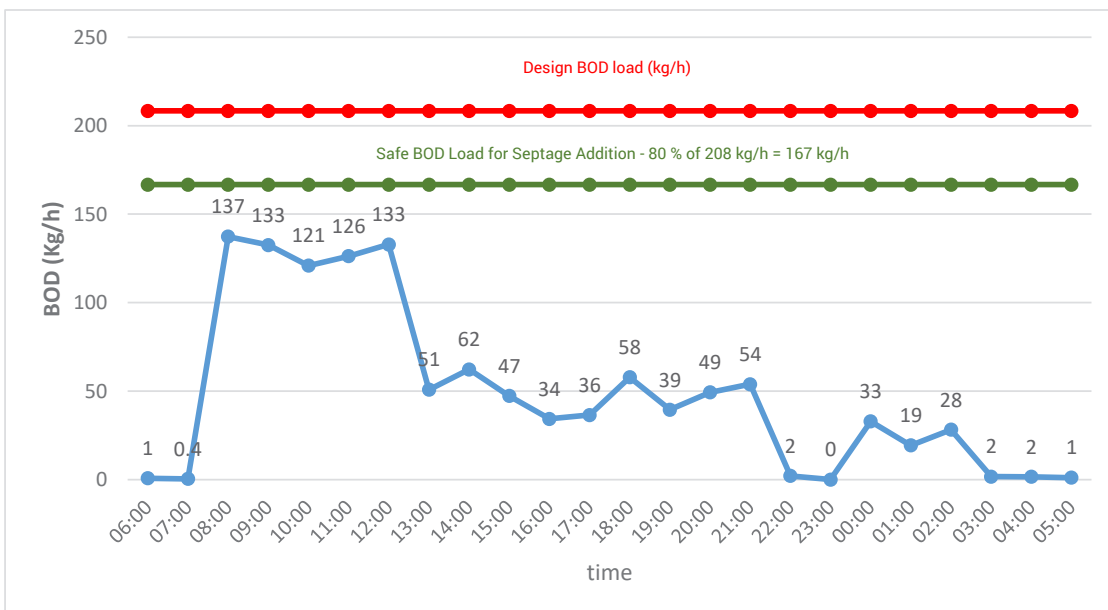
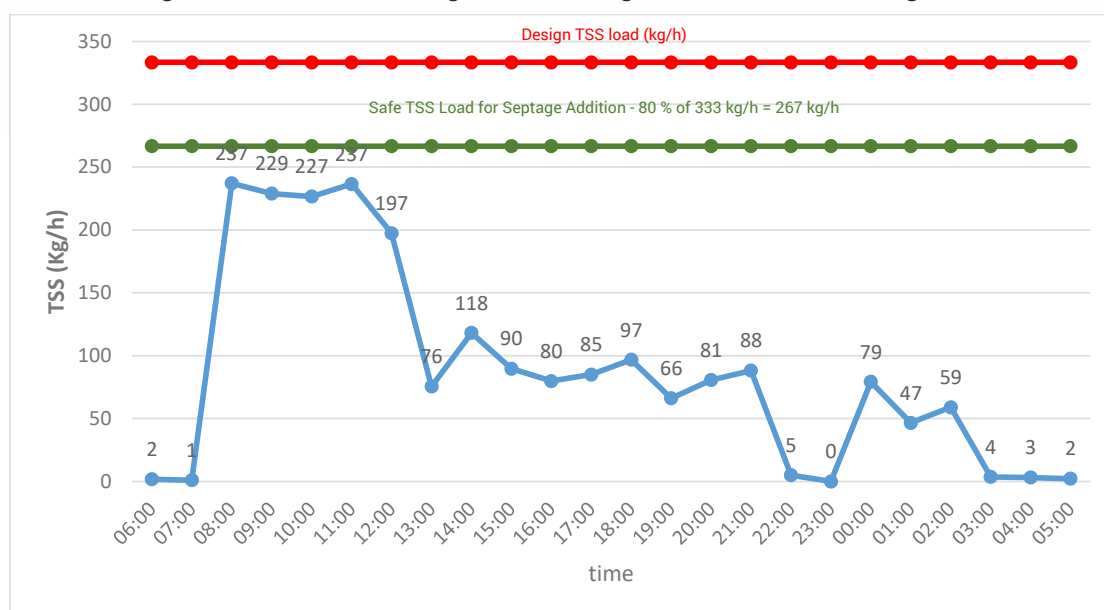



Figure 32: Actual TSS loading variation, Design TSS load, and safe design load



Actual COD, BOD, and TSS loading during working hours( i.e. from 8:00 am to 12:00 noon) was higher than the design loading. Therefore, during this duration, co-treatment is not possible. To achieve co-treatment at the STP, the septage should be added between 1:00 pm to 9:00 pm. Moreover, there is no intermittent flow from 9:00 pm to 7:00 am; therefore, septage addition is not advisable.

Assuming the volume of 1 truck/tanker = 3 m<sup>3</sup>

Therefore, organic loading of 1 truck/tanker

COD loading = 30 kg COD/m<sup>3</sup> x 3 m<sup>3</sup>/truck = 90 kg COD/truck

BOD loading = 20 kg BOD/m<sup>3</sup> x 3 m<sup>3</sup>/truck = 60 kg BOD/truck

TSS loading = 30 kg TSS/m<sup>3</sup> x 3 m<sup>3</sup>/truck = 90 kg TSS/truck

Table 22: Loading condition and disposing criteria

Duration	Considering COD	Considering BOD	Considering TSS
	Safe COD loading = 300 kg/h	Safe BOD loading = 167 kg/h	Design TSS loading = 267 kg/h
	Septage Tanker Load= 90 kg COD/Tanker	Septage Tanker Load= 60 kg BOD/Tanker	Septage Tanker Load= 90 kg TSS/Tanker
Between 13:00 to 21:00	Average actual COD loading = 95 kg/h	Average actual BOD loading = 48 kg/h	Average actual TSS loading = 87 kg/h
	300 kg/h – 95 kg/h = <b>205 kg/h or 2 truck/h can be disposed</b>	167 kg/h – 48 kg/h = <b>119 kg/h or 2 truck/h can be disposed</b>	267 kg/h – 87 kg/h = <b>180 kg/h or 2 truck/h can be disposed</b>

Therefore, total no of trucks can be disposed = 8 x 2 truck= 16 trucks

Volume of septage that can be disposed = 16 trucks x 3m<sup>3</sup>/truck = 48m<sup>3</sup>

### 3.6.A Case-Study On Strategies of Co-Treatment of Septage at 5 Mld Stp, Indira Nagar, Dehradun

#### 3.6.1 Introduction

The 5 MLD STP at Indira Nagar, Dehradun is based on the SBR process. It comprises of receiving chamber, coarse screen (manual and mechanical), raw sewage sump, pump house, stilling chamber, fine screen (manual and mechanical), grit chamber, parshall flume, SBR basin, chlorine contact tank, sludge sump and centrifuge as shown in Figure 34.

#### 3.6.2. Flowsheet

The flowsheet of 5 MLD STP is shown in Figure 34

Figure 33: Flow diagram of 5 MLD STP based on SBR process

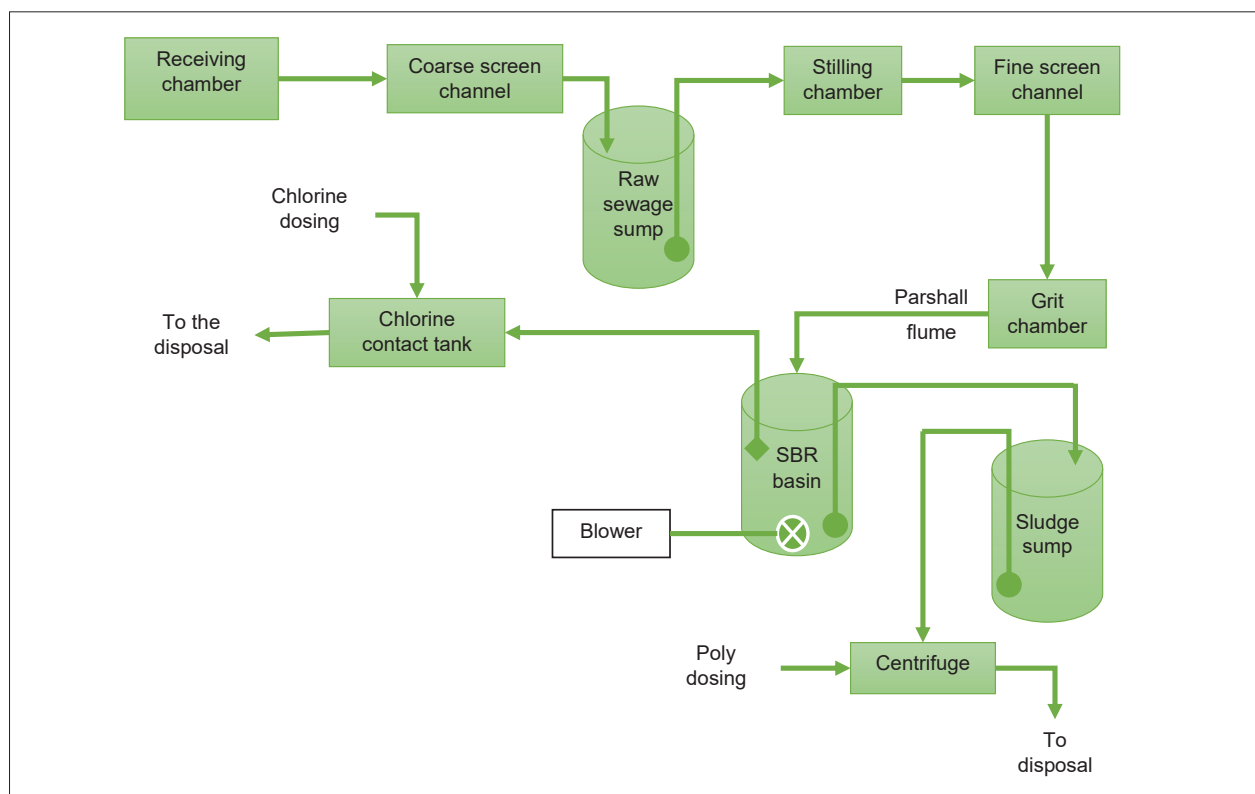

#### 3.6.3. Design parameters & unit sizes

The STP is designed for an average flow of 5 MLD and peak flow of 12.5 MLD. The design inlet and outlet water quality parameters are summarized in Table 23. The unit sizes are summarised in Table 24.

Table 23: Inlet and Outlet Water Quality Parameters

S.No.	Parameter	Units	Influent	Effluent
1.	BOD	mg/L	250	<10
2.	COD	mg/L	450	<50
3.	TSS	mg/L	400	<15
4.	TKN	mg/L	15	-
5.	NO <sub>3</sub> -N	mg/L	-	10
6.	T-P	mg/L	5	<2

**Table 24: Unit Sizes of STP**

S.no.	Description	Dimensions	No.
1.	Receiving chamber	2.2 m x 2.2 m x 1 m SWD	1
2.	Mechanical coarse screen	2.5 m x 0.7 m x 0.3 m SWD	1
3.	Manual coarse screen	2.5 m x 0.7 m x 0.3 m SWD	1
4.	Raw sewage sump	5.5 m Dia. x 2.0 m SWD	1
5.	The raw sewage pump house	5.5 m Dia. X 4.0 m ht.	1
6.	Stilling chamber	2.2 m x 2.2 m x 1.0 m SWD	1
7.	Mechanical fine screen	2.0 m x 0.5 m x 0.4 m SWD	1
8.	Manual fine screen	2.0 m x 0.5 m x 0.4 m SWD	1
9.	Grit chamber	3.8 m x 3.8 m x 0.9 m SWD	1
10.	Parshall flume	1.5 m x 0.4 m x 0.6 m SWD	1
11.	SBR/C-Tech basin	25.6 m x 12.8 m x 4.9 m SWD	2
12.	Chlorine contact tank	12.8 m x 8.2 m x 2.0 m SWD	1
13.	Chlorination room	6.0 m x 4.0 m x 4.5 m ht.	1
14.	Sludge sump	5.0 m x 2.35 m x 2.0 m SWD	1
15.	Sludge pump house	6.0 m x 5.0 m x 4.0 m ht.	1
16.	Centrifuge house	6.0 m x 5.0 m x 8.0 m ht.	1
17.	Blower room	12.5 m x 10.0 m x 8.0 m ht.	1

**3.6.4. Flow and water quality analysis**

**Flow Variation**

Flow variation is needed for obtaining peak and lean flows. The peak factor is one of the essential criteria for the design of preliminary treatment units and the flexibility of the biological process to handle peak flows. The observed average flow was 350 m<sup>3</sup>/h or 8.4 MLD, and peak flow was 588 m<sup>3</sup>/h with a peak factor of 1.68 on 8-9<sup>th</sup> July 2019, which is lower than the design peak factor. The higher flow was observed due to rainwater infiltration in the domestic sewer. Figure 34 shows the flow variation.

**Figure 34: Variation of inflow at STP**

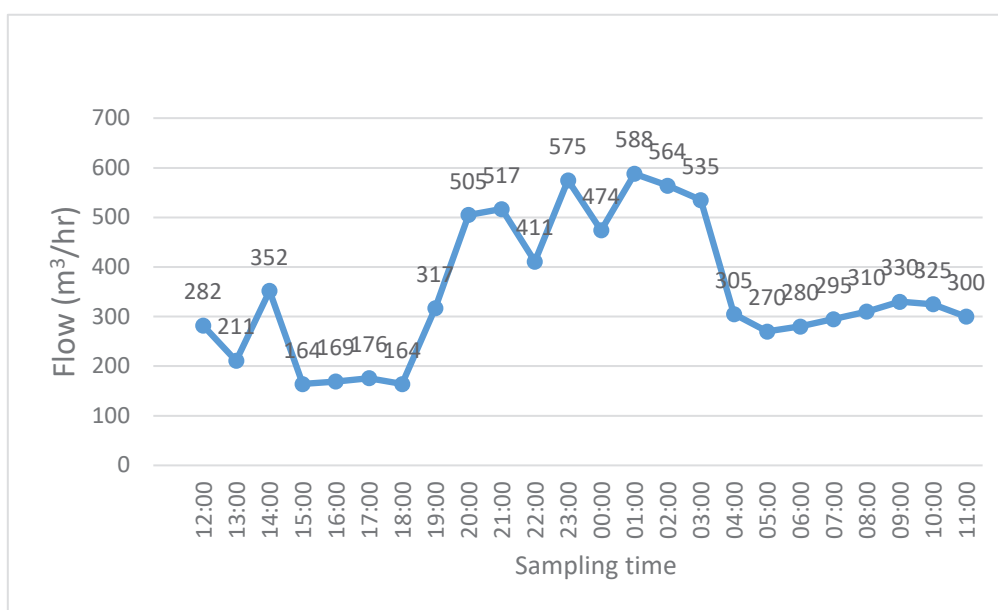

### COD Variation

Figure 35 shows the COD variation in raw sewage and treated effluent. The minimum and maximum COD in raw sewage varied from 87 mg/L to 201 mg/L with a composite value of 132 mg/L. The time variable effluent COD concentration is in the range of 17 mg/L to 26 mg/L with a composite value of 23 mg/L.

Figure 35: COD variation at STP

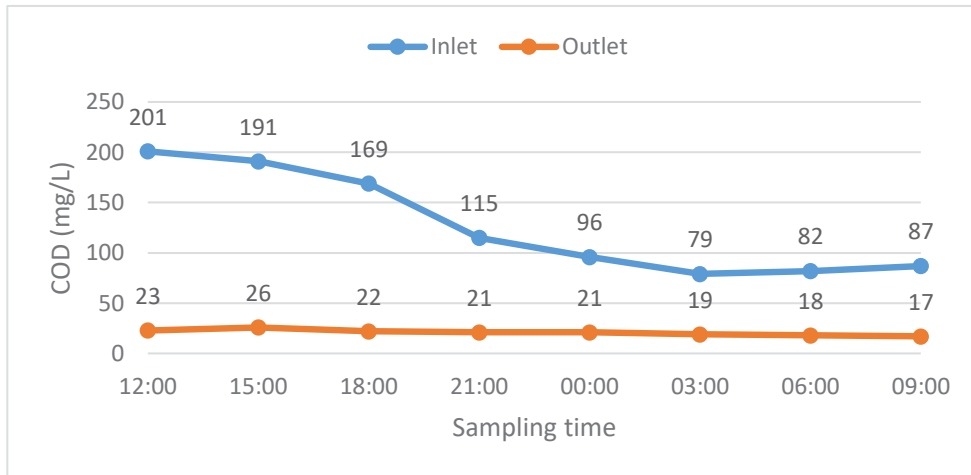

### BOD Variation

Figure 36 shows the BOD variation in raw sewage and treated effluent. The minimum and maximum BOD in the raw sewage varied from 43 mg/L to 126 mg/L with a composite value of 71 mg/L. The time variable effluent BOD concentration is in the range of 5.4 mg/L to 6.2 mg/L with a composite value of 5.6 mg/L.

Figure 36: BOD variation at STP

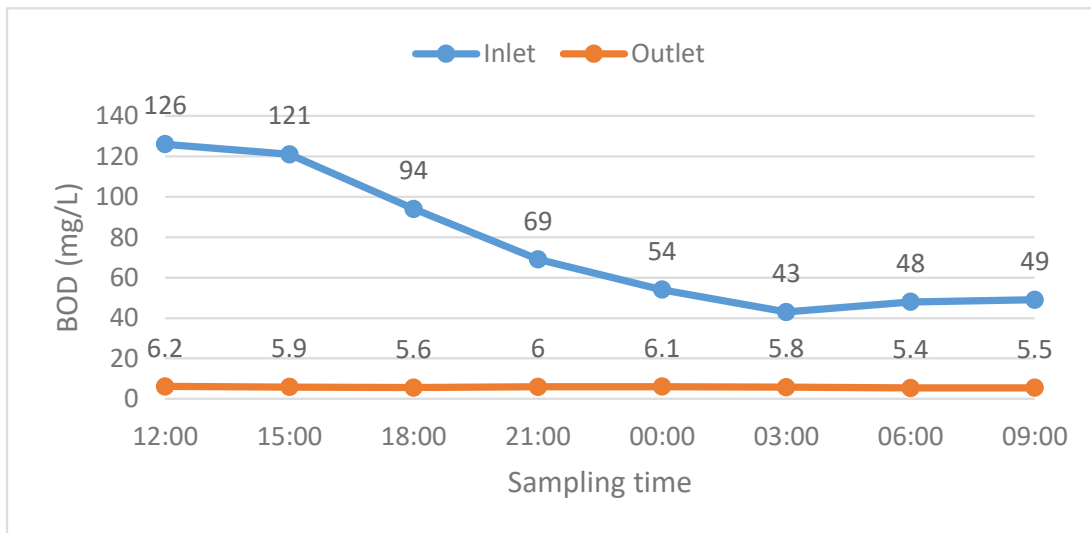

### TSS Variation

Figure 37 shows the TSS variation in raw sewage and treated effluent. The minimum and maximum TSS in the raw sewage varied from 91 mg/L to 191 mg/L with a composite value of 139 mg/L. The time variable effluent TSS concentration is in the range of 3.2 mg/L to 4.6 mg/L with a composite value of 3.3 mg/L.

Figure 37: TSS variation at STP

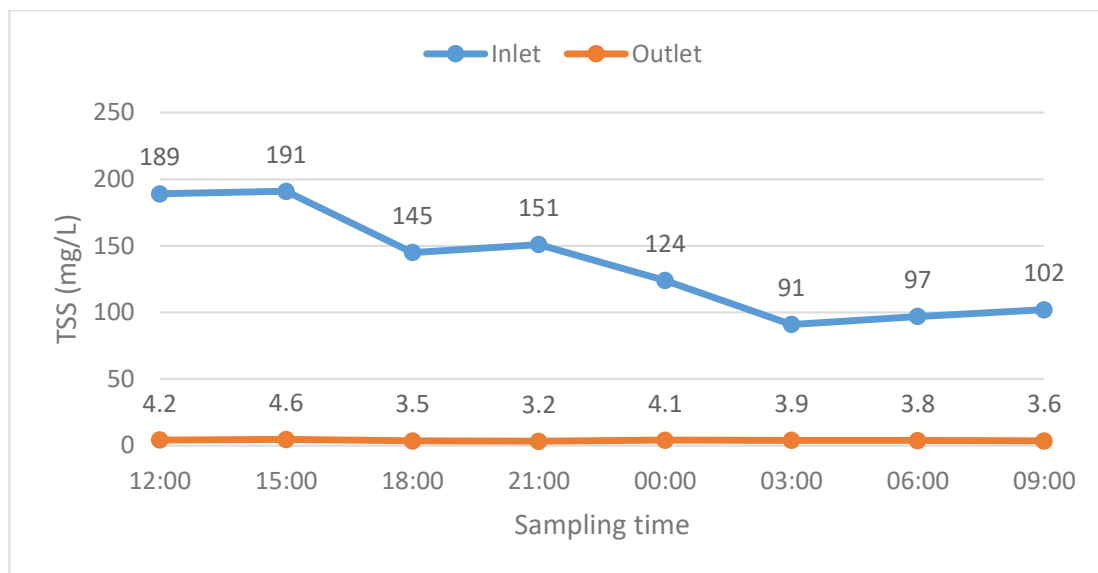

### 3.6.5 Composite sampling and analysis

For composite sampling, representative samples were collected at a regular time interval of 3-h on 8-9th July 2019. The flow rate was recorded by pump operation. The representative samples were then integrated by mixing together the portions of the individual samples relative to the flowrate at sampling time to make a composite sample. Analyses of alkalinity, COD, BOD, TSS, NH<sub>4</sub>-N, NO<sub>3</sub>-N, and PO<sub>4</sub>-P were carried out as per the Standard Methods (APHA, 2012) and presented in Table 25.

Table 25: Results of Composite Sample

S.No.	Parameters	Unit	Raw sewage	Outlet	Desired Effluent Quality
1	Alkalinity as CaCO <sub>3</sub>	mg/L	180	120	-
2	pH		7.1	7.2	-
3	Turbidity	NTU	65	1.8	-
4	BOD	mg/L	71	5.6	10
5	COD	mg/L	132	23	50
6	TSS	mg/L	139	3.3	15
7	NH <sub>4</sub> -N	mg/L	21.2	0.6	-
8	NO <sub>3</sub> -N	mg/L	0.5	5.8	10
9	TN	mg/L	24.4	6.5	
10	PO <sub>4</sub> -P	mg/L	1.2	0.1	2 (as TP)

### 3.6.6. Strategies for septage addition for design and actual COD, BOD and TSS loadings

The design COD, BOD, and TSS loadings are summarized in the following Table 26. The safe load for septage addition is assumed as 80% of the design load. The safety factor is taken for consideration of harmful effects by Oil & Grease, cleaning agents, etc., on BOD, COD, TSS, and nutrient removal.

Table 26: Design COD, BOD, and TSS Loading

Parameter	Design Flow (m <sup>3</sup> /h)	Design Inlet Water Quality (mg/L)	Design Loading (kg/h)	Safe Loading for co-treatment with septage addition (80% of Design Load)
COD	5000 m <sup>3</sup> /d x 1 day/24 h = 208 m <sup>3</sup> /h	COD = 450 mg/L or 0.45 kg/m <sup>3</sup>	208 m <sup>3</sup> /h x 0.45 kg/m <sup>3</sup> = 93.6 kg/h	0.8 x 93.6kg/h = 74.8 or 75 kg/h
BOD	208 m <sup>3</sup> /h	BOD = 250 mg/L or 0.25 kg/m <sup>3</sup>	208 m <sup>3</sup> /h x 0.25 kg/m <sup>3</sup> = 52 kg/h	0.8 x 52 kg/h = 41.6 or 42 kg/h
TSS	208 m <sup>3</sup> /h	TSS = 400 mg/L or 0.45 kg/m <sup>3</sup>	208 m <sup>3</sup> /h x 0.4 kg/m <sup>3</sup> = 83.2 kg/h	0.8 x 83.2 kg/h = 66.5 or 67 kg/h

The design, safe and actual COD, BOD, and TSS loading is plotted in figures 38-40.

Figure 38: Actual COD loading variation, Design COD load, and safe design load

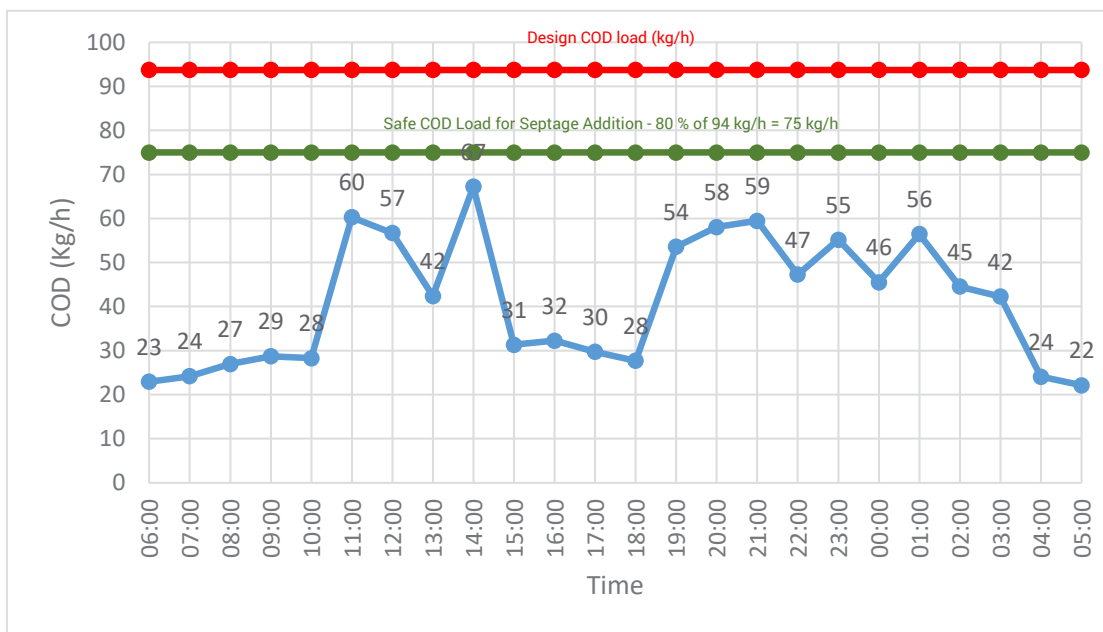

**Figure 39: Actual BOD loading variation, Design BOD load, and safe design load**

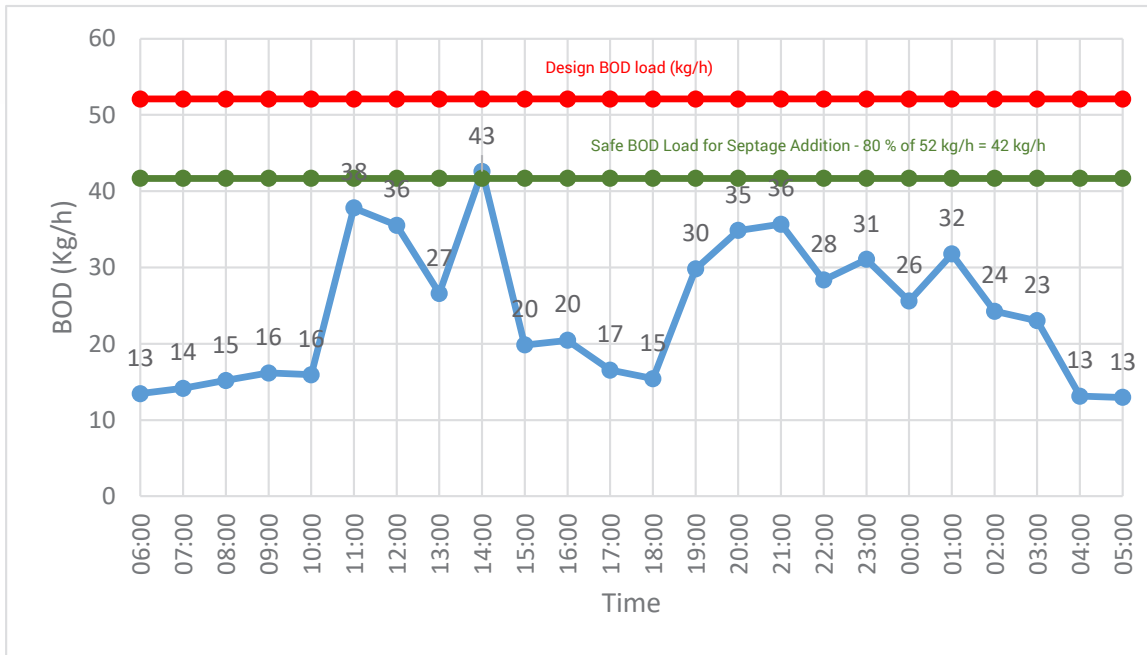

**Figure 40: Actual TSS loading variation, Design TSS load, and safe design load**

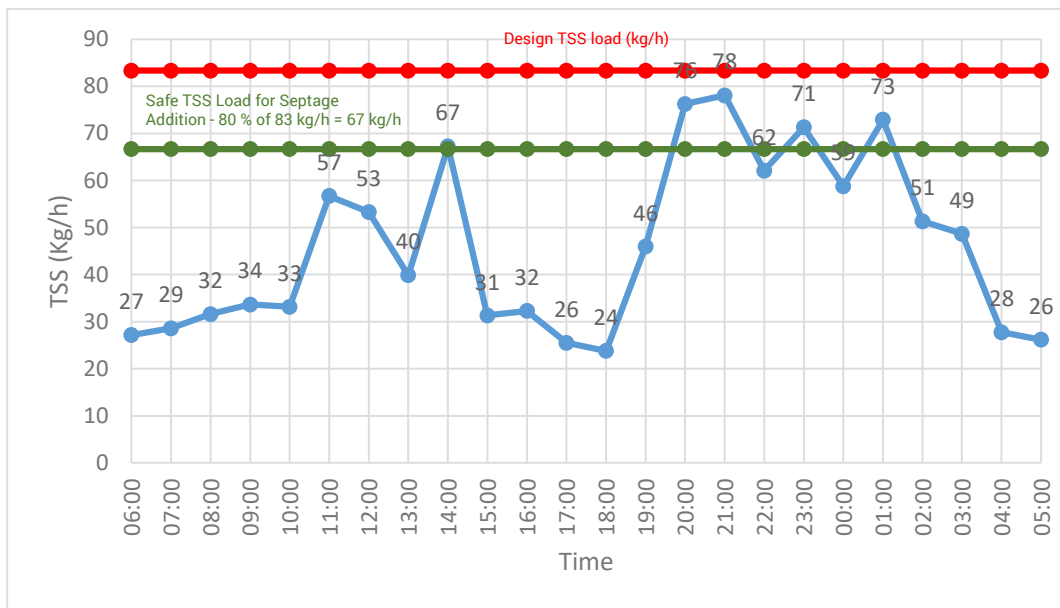

Actual COD, BOD, and TSS loading throughout the day (i.e., 10:00 am to 1:00 am) was higher than design loading. Therefore, during this duration, co-treatment is not possible. To achieve co-treatment at the STP, the septage should be added between 1:00 am to 10:00 am. After providing a storage facility, co-treatment can be done during the provided hours.

Assuming the volume of 1 truck/tanker = 3 m<sup>3</sup>

Therefore, organic loading of 1 truck/tanker

COD loading = 30000 mg/L x 3 m<sup>3</sup>/truck = 90 kg/truck

BOD loading = 20000 mg/L x 3 m<sup>3</sup>/truck = 60 kg/truck

TSS loading = 30000 mg/L x 3 m<sup>3</sup>/truck = 90 kg/truck

**Table 27: Loading condition and disposing criteria**

Duration	Considering COD	Considering BOD	Considering TSS
	Safe COD loading = 75 kg/h	Safe BOD loading = 42 kg/h	Safe TSS loading = 67 kg/h
	Septage Tanker load = 90 kg COD/Tanker	Septage Tanker load = 60 kg BOD/Tanker	Septage Tanker load = 90 kg TSS/Tanker
Between 1:00 am - 10:00 am	Average actual COD loading = 32 kg/h	Average actual BOD loading = 18 kg/h	Average actual TSS loading = 38 kg/h
	75 kg/h - 32 kg/h = 43 kg COD/h or 0.5 truck/h can be disposed	42 kg/h - 18 kg/h = 24 kg/h or 0.4 truck/h can be disposed	67 kg/h - 38 kg/h = 29 kg/h or 0.3 truck/h can be disposed

Therefore, total no of trucks can be disposed =  $9 \times 0.3 \text{ truck} = 2.7$  or 3 trucks  
 Volume of septage that can be disposed =  $3 \text{ trucks} \times 3 \text{ m}^3/\text{truck} = 9 \text{ m}^3$

### 3.7. A Case-Study On Strategies of Co-Treatment of Septage at 68 MLD Stp, Dehradun

#### 3.7.1 Introduction

The 68 MLD STP at Kargi, Dehradun is based on the SBR process. It comprises of receiving chamber, coarse screen (manual and mechanical), raw sewage sump, pump house, stilling chamber, fine screen (manual and mechanical), grit chamber, parshall flume, SBR basin, chlorine contact tank, sludge sump, and centrifuge.

#### 3.7.2 Flow Sheet

The typical flowsheet of STP is provided in Figure 41

**Figure 41: Flowsheet of 68 MLD STP**

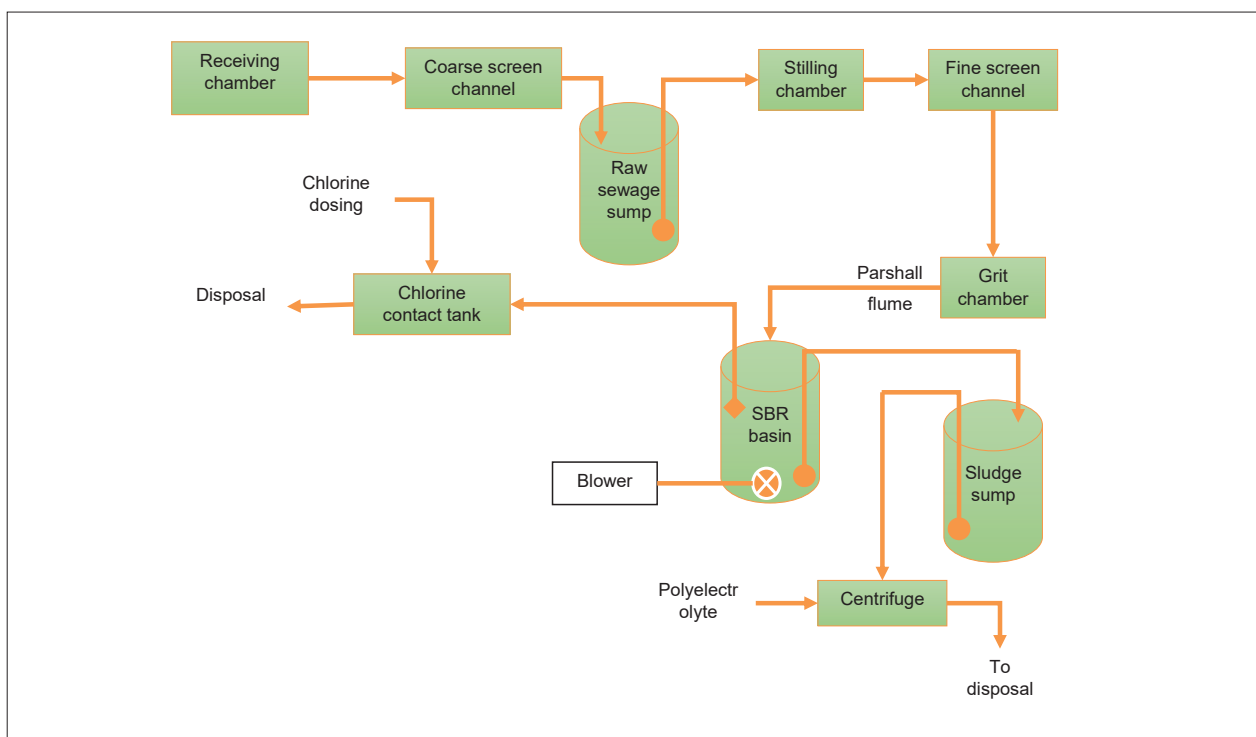



### 3.7.3. Design parameters & unit sizes

The STP is designed for an average flow of 68 MLD and a peak flow of 153 MLD. The design inlet and outlet water quality parameters are summarized in Table 28. The unit sizes are summarised in Table 29.

**Table 28: Inlet and Outlet Water Quality Parameters**

S.No.	Parameter	Units	Influent	Effluent
1.	BOD	mg/L	250	<10
2.	COD	mg/L	500	<100
3.	TSS	mg/L	400	<10

**Table 29: Unit Sizes of STP**

S.no.	Description	Dimensions	No.
1.	Receiving chamber	Volume - 53.13 m <sup>3</sup>	1
2.	Mechanical coarse screen	5.75 m x 1.4 m x 1.35 m SWD	2
3.	Manual coarse screen	5.75 m x 1.4 m x 1.35 m SWD	1
4.	Raw sewage sump (wet well)	16.5 m Dia. x 2.56 m SWD	1
5.	The raw sewage pumping station	16.5 m Dia. X 5.0 m ht.	1
6.	Stilling chamber	4.3 m x 4.2 m x 3.0 m SWD	1
7.	Mechanical fine screen	7.25 m x 1.45 m x 1.25 m SWD	1
8.	Manual fine screen	7.25 m x 1.45 m x 1.25 m SWD	2
9.	Grit chamber	9.0 m x 9.0 m x 0.9 m SWD	2
10.	SBR/C-Tech basin	60.45 m x 33.5 m x 5.8 m SWD	4
11.	Chlorine contact tank	50.0 m x 1.9 m x 1.5 m SWD	1
12.	Chlorination room	10.0 m x 5.0 m x 4.5 m ht.	1
13.	Sludge sump	10.0 m x 8.55 m x 3.5 m SWD	1
14.	Sludge pump house	12.0 m x 10.0 m x 4.5 m ht.	1
15.	Sludge drying area	Area = 475 m <sup>2</sup>	
16.	Centrifuge house	10.0 m x 6.5 m x 9.0 m ht.	1
17.	Blower room	37.0 m x 10.0 m x 10.0 m ht.	1

### 3.7.4 Flow and water quality analysis

#### Flow Variation

Flow variations are needed for obtaining peak and lean flows. The peak factor is one of the essential criteria for the design of preliminary treatment units and the flexibility of the biological process to handle peak flows. The average flow measured was 734 m<sup>3</sup>/h or 17.62 MLD, and peak flow was 2,953 m<sup>3</sup>/h with a peak factor of 4 on 14-15<sup>th</sup> June 2019, which is higher than the design peak factor. Figure 42 shows the flow variations.

Figure 42: Variation of inflow at STP

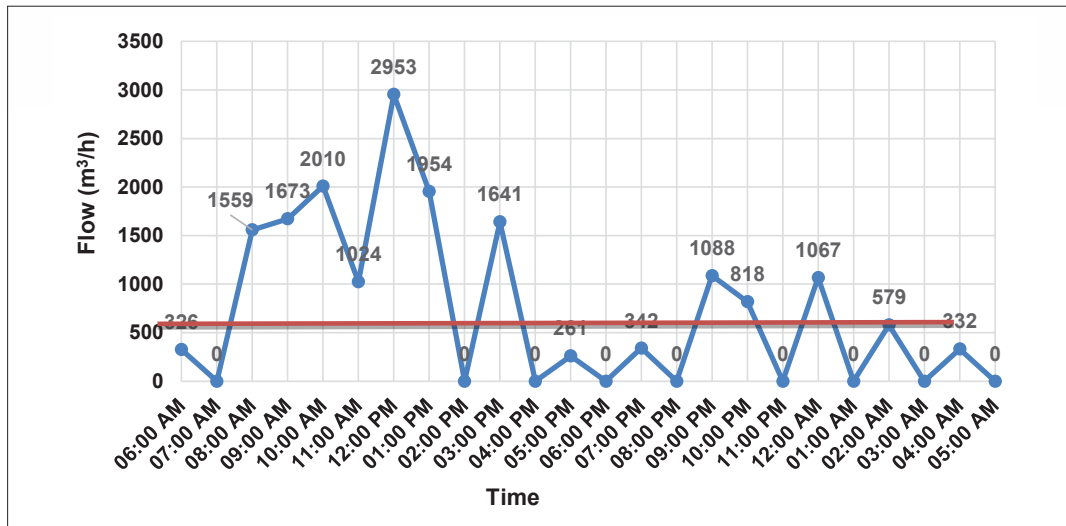

### COD Variation

Figure 43 shows the COD variation in raw sewage and treated effluent. The minimum and maximum COD in the raw sewage varied from 418 mg/L to 830 mg/L with a composite value of 547 mg/L. The time variable effluent COD concentration is in the range of 28 mg/L to 40 mg/L with a composite value of 33 mg/L.

Figure 43: COD variation at STP

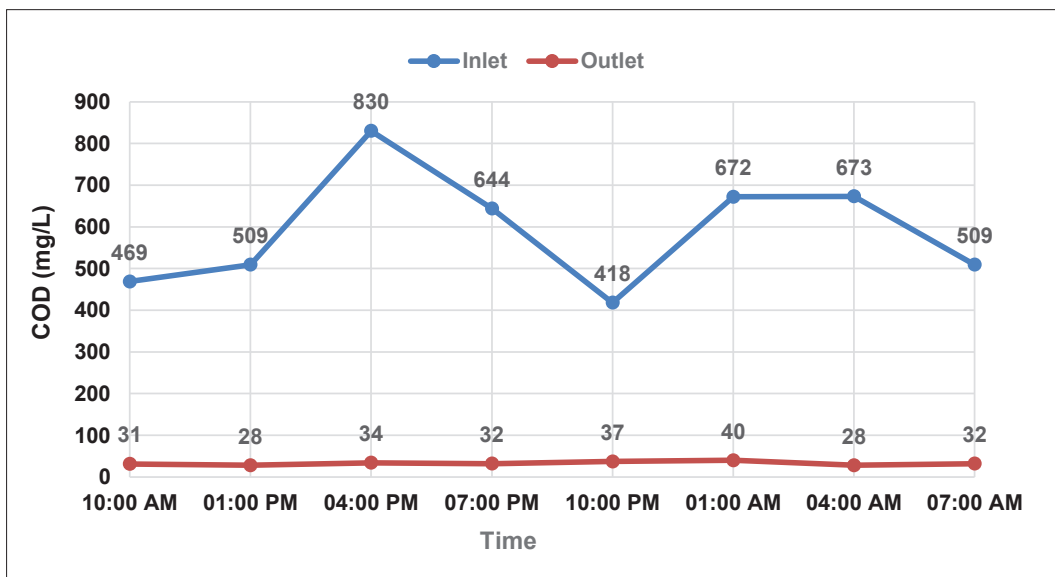

### BOD Variation

Figure 44 shows the BOD variation in raw sewage and treated effluent. The minimum and maximum BOD in the raw sewage varied from 276 mg/L to 481 mg/L with a composite value of 298 mg/L. The time variable effluent BOD concentration is in the range of 9 mg/L to 13 mg/L with a composite value of 11 mg/L.

Figure 44: BOD variation at STP

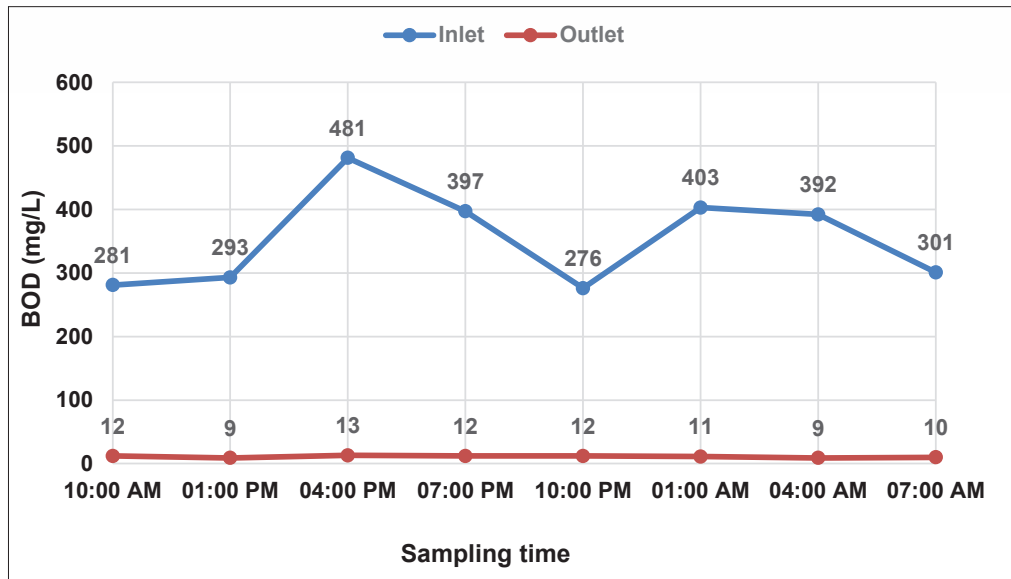

### TSS Variation

Figure 45 shows the TSS variation in raw sewage and treated effluent. The minimum and maximum TSS in the raw sewage varied from 294 mg/L to 530 mg/L with a composite value of 406 mg/L. The time variable effluent TSS concentration is in the range of 7 mg/L to 13 mg/L with a composite value of 9 mg/L.

Figure 45: TSS variation at STP

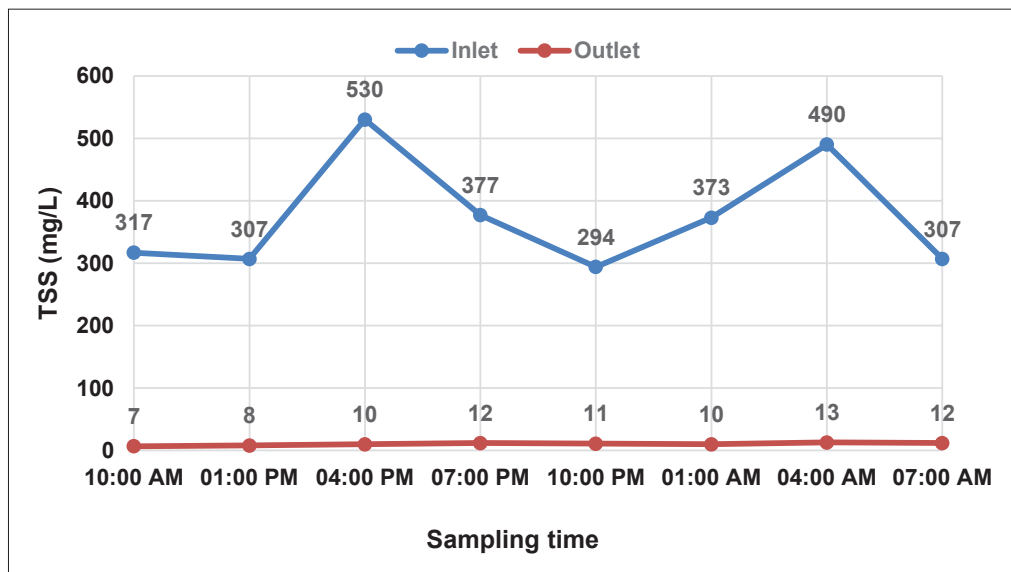

### 3.7.5. Composite sampling & analysis

For composite sampling, representative samples were collected at a regular time interval of 3-h on 14-15<sup>th</sup> June 2019. The flow rate was recorded by pump operation. The representative samples were then integrated by mixing together the portions of the individual samples relative to the flowrate at sampling time to make a composite sample. Analyses of alkalinity, COD, BOD, TSS, NH<sub>4</sub>-N, NO<sub>3</sub>-N, and PO<sub>4</sub>-P were carried out as per the Standard Methods (APHA, 2012) and presented in Table 30. The results show that almost all parameters satisfy the design outlet quality.

**Table 30: Results of Composite Sample**

S.No.	Parameters	Unit	Raw sewage	Outlet	Desired Effluent Quality
1	Alkalinity as CaCO <sub>3</sub>	mg/L	420	270	-
2	pH		7.1	7.2	-
3	Turbidity	NTU	65	1.8	-
4	BOD	mg/L	298	11	10
5	COD	mg/L	547	33	100
6	TSS	mg/L	406	9	10
7	NH <sub>4</sub> -N	mg/L	45.3	1	-
8	NO <sub>3</sub> -N	mg/L	0.1	4.1	-
9	TN	mg/L	48.6	7.2	-
10	PO <sub>4</sub> -P	mg/L	3.5	0.4	-

### 3.7.6 Strategies for septage addition for design and actual COD, BOD and TSS loadings

The design COD, BOD, and TSS loadings are summarized in the following Table 31. The safe load for septage addition is assumed as 80% of the design load. The safety factor is taken for consideration of harmful effects by Oil & Grease, cleaning agents, etc., on BOD, COD, TSS, and nutrient removal.

**Table 31: Design COD, BOD, and TSS Loading**

Parameter	Design Flow (m <sup>3</sup> /h)	Design Inlet Water Quality (mg/L)	Design Loading (kg/h)	Safe Loading for co-treatment with septage addition (80 % of Design Load)
COD	68000 m <sup>3</sup> /d x 1 day/24 h = 2833 m <sup>3</sup> /h	COD = 500 mg/L or 0.5 kg/m <sup>3</sup>	2833 m <sup>3</sup> /h x 0.5kg/m <sup>3</sup> = 1416.5 kg/h	0.8 x 1416.5 kg/h = 1133.2 kg/h
BOD	2833 m <sup>3</sup> /h	BOD = 250 mg/L or 0.25 kg/m <sup>3</sup>	2833 m <sup>3</sup> /h x 0.25 kg/m <sup>3</sup> = 708 kg/h	0.8 x 708 kg/h = 566 kg/h
TSS	2833 m <sup>3</sup> /h	TSS = 400 mg/L or 0.4 kg/m <sup>3</sup>	2833 m <sup>3</sup> /h x 0.4 kg/m <sup>3</sup> = 1133.2 kg/h	0.8 x 1133.2kg/h = 906 kg/h

The assumed septage tanker loading in terms of COD, BOD and TSS is calculated as follows:

Assuming the volume of 1 truck/tanker = 3 m<sup>3</sup>

Therefore, organic loading of 1 truck/tanker

$$\text{COD loading} = 30 \text{ kg COD/m}^3 \times 3 \text{ m}^3/\text{truck} = 90 \text{ kg COD/truck}$$

$$\text{BOD loading} = 20 \text{ kg BOD/m}^3 \times 3 \text{ m}^3/\text{truck} = 60 \text{ kg BOD/truck}$$

$$\text{TSS loading} = 30 \text{ kg TSS/m}^3 \times 3 \text{ m}^3/\text{truck} = 90 \text{ kg TSS/truck}$$

The design, safe and actual COD, BOD, and TSS loading is plotted in figures 46-48.

Figure 46: Actual COD loading variation, Design COD load, and safe design load

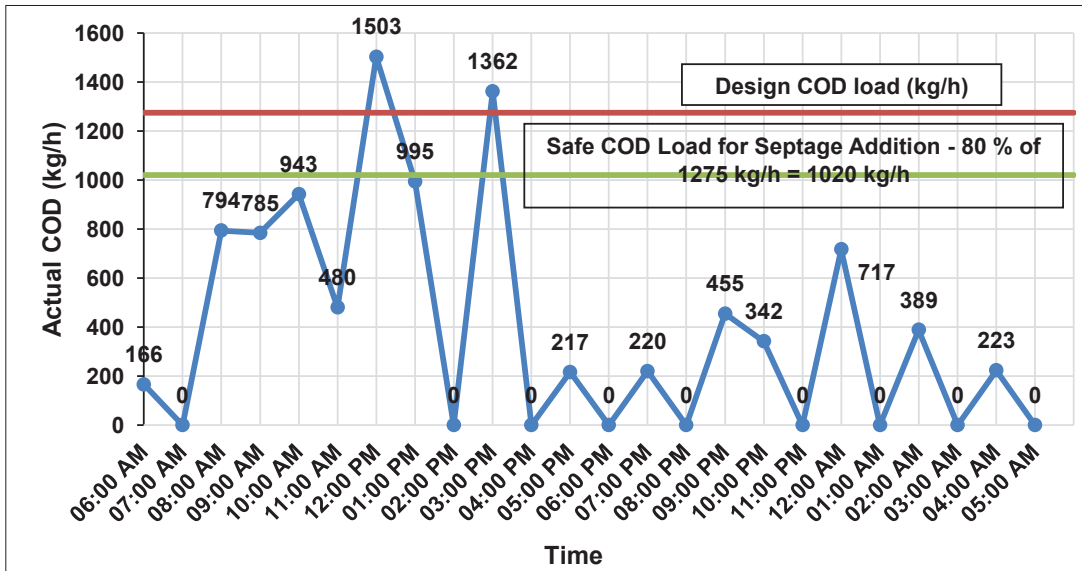

Figure 47: Actual BOD loading variation, Design BOD load, and safe design load

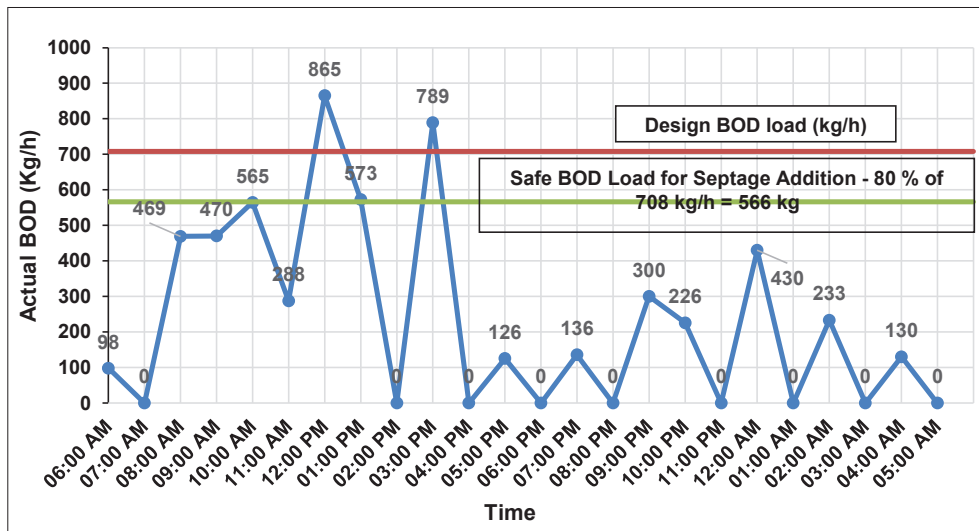
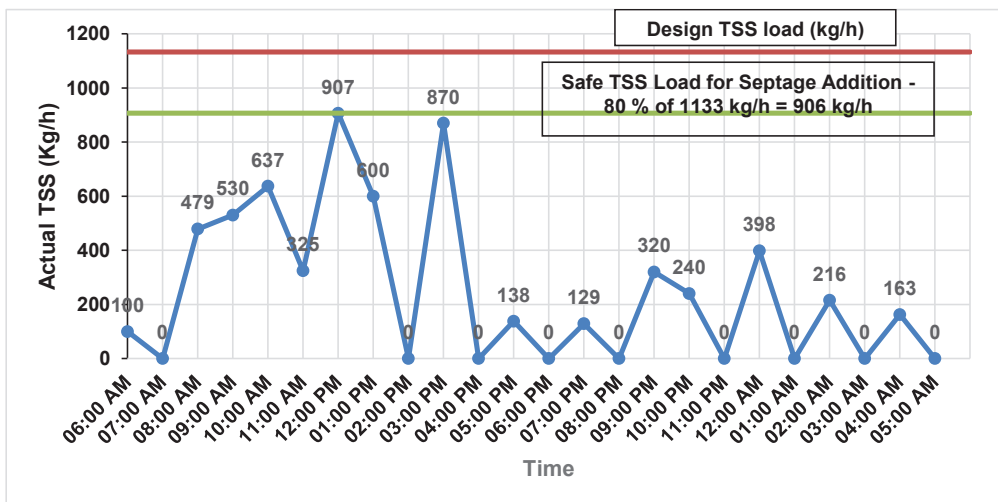

Figure 48: Actual TSS loading variation, Design TSS load, and safe design load



Actual COD, BOD, and TSS loading during the day (i.e. 8:00 am to 4:00 pm) was intermittent and higher than design loading capacity. Therefore, during this duration, co-treatment is not possible. To achieve co-treatment at the STP, the septage should be added between 4:00 pm to 8:00 am. After providing a storage facility, co-treatment can be done during the provided hours.

Assuming the volume of 1 truck/tanker = 3 m<sup>3</sup>

Therefore, organic loading of 1 truck/tanker

COD loading = 30000 mg/L x 3 m<sup>3</sup> /truck = 90 kg/truck

BOD loading = 20000 mg/L x 3 m<sup>3</sup> /truck= 60 kg/truck

TSS loading = 30000 mg/L x 3 m<sup>3</sup> /truck = 90 kg/truck

**Table 32: Loading condition and disposing criteria**

Duration	Considering COD	Considering BOD	Considering TSS
	Safe COD loading = 1133 kg/h	Safe BOD loading = 566 kg/h	Safe TSS loading = 906 kg/h
	Septage Tanker load = 90 kg COD/Tanker	Septage Tanker load = 60 kg BOD/Tanker	Septage Tanker load = 90 kg TSS/Tanker
Between 4:00 pm – 8:00 am	Average actual COD loading = 207 kg/h	Average actual BOD loading = 126 kg/h	Average actual TSS loading = 128 kg/h
	1133 kg/h - 207 kg/h = <b>926 kg/h</b> <b>or 10 truck/h can be disposed</b>	566 kg/h - 126 kg/h = <b>440 kg/h</b> <b>or 7 truck/h can be disposed</b>	906 kg/h – 128 kg/h = <b>778 kg/h</b> <b>or 8.6 truck/h can be disposed</b>

Total no of trucks can be disposed = 7 trucks x 16 = 112 trucks

Volume of septage that can be disposed = 112 truck × 3 m<sup>3</sup> / truck = 336 m<sup>3</sup>

### 3.8.A Case-Study on Strategies of Co-Treatment of Septage at 5 MLD STP, Tehri

#### 3.8.1. Introduction

The 5 MLD STP at Tehri is based on Extended aeration and tertiary coagulation process. It comprises of the inlet chamber, fine screen (manual and mechanical), grit chamber, parshall flume, aeration tank, secondary settling tank, flash mixer, clariflocculator, chlorine contact tank, sludge sump, sludge thickener, and centrifuge.

### 3.8.2 Flowsheet

The typical flowsheet of STP is provided in Figure 49.

Figure 49: Flowsheet of STP

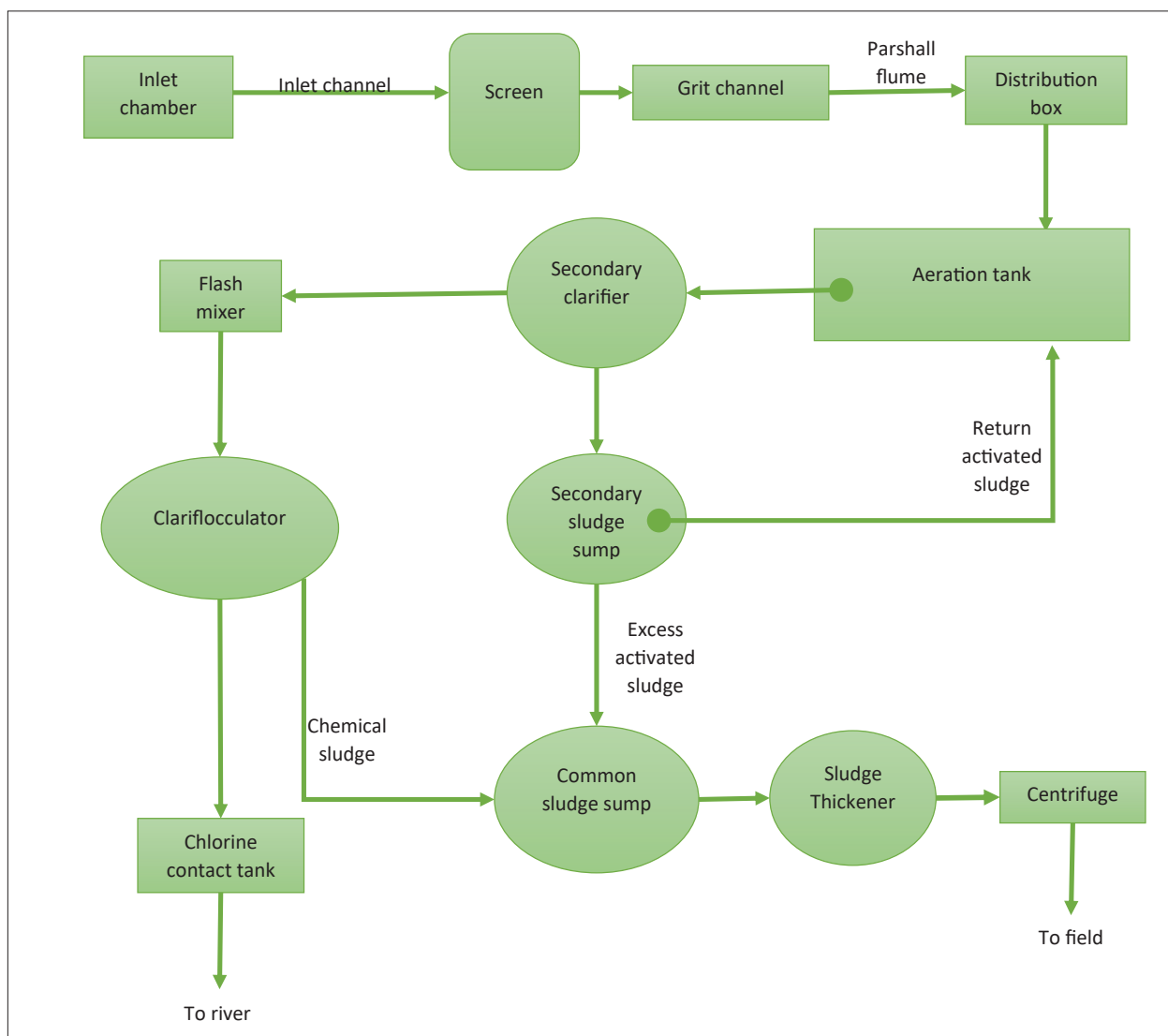

### 3.8.3. Design parameters & unit sizes

The STP is designed for 5 MLD average flow and 12.5 MLD peak flow. The design inlet and outlet water quality parameters are summarized in Table 33. The unit sizes are summarised in Table 34.

Table 33: Inlet and Outlet Water Quality Parameters

S.No.	Parameter	Units	Influent	Effluent
1.	BOD	mg/L	300	<5
2.	TSS	mg/L	600	<10

**Table 34: Unit sizes of STP**

S.No.	Description	Dimensions	No.
1.	Inlet chamber	3.0 m x 2.0 m x 2.2 m L.D.	1
2.	Inlet channel	4.0 m long x 0.6 m wide x 0.4 m L.D.	1
3.	Screen channels	3.0 m long x 0.8 m wide x 0.55 m L.D.	2
4.	Grit channels	15.0 m x 1.0 m x 1.2 m	2
5.	Parshall flume	0.3 m T <sup>h</sup> roat width	1
6.	Distribution box	2.5 m x 2.5 m	1
7.	Aeration tanks	28.6 m x 14.3 m 4.8 m L.D.	2
8.	Secondary clarifies	14.6 m Dia x 3.0 m SWD	2
9.	Return Sludge		
A.	sump	6.0 m x 6.0 m x 2.35 m L.D.	1
B.	Pumphouse	6.0 m x 4.0 m	1
10.	Flash mixture	2.7 m x 2.7 m x 2.9 m L.D.	1
11.	Clariflocculator	17.5 m Dia x 3.0 m SWD	1
12.	Chemical sludge		
A.	Sludge sump	4.0 m x 1.0 m x 1.5 m L.D.	1
B.	Sludge pump house	4.0 m x 4.0 m	1
13.	Sludge thickener	9.0 m Dia x 3.0 m SWD	1
14.	Thickened Sludge		
A.	Sump	4.0 m x 1.0 m x 1.5 m L.D.	1
B.	Pumphouse	4.0 m x 4.0 m	1
15.	Chlorine contact tank	2.0 m x 4.0 m x 2.0 m L.D.	1
16.	Dewatering sump	5.0 m Dia x 2.0 m L.D.	1
17.	Centrifuge Shed	5.0 m x 4.5 m	1
18.	Chemical house	20.0 m x 10.0 m	1
19.	D.G. set room	10.0 m x 5.0 m	
20.	Cascade aerator	2.8 m Dia x 2.0 m HT	

### 3.8.4 Flow and water quality

#### Flow Variation

Flow variation is needed for obtaining peak and lean flows. The peak factor is one of the essential criteria for the design of preliminary treatment units and the flexibility of the biological process to handle peak flows. The observed average flow was 95 m<sup>3</sup>/h or 2.28 MLD, and peak flow was 133 m<sup>3</sup>/h with a peak factor of 1.4 on 6-7<sup>th</sup> July 2019, which is lower than the design peak factor. Figure 50 shows the flow variation.



**Figure 50: Variation of inflow at STP**

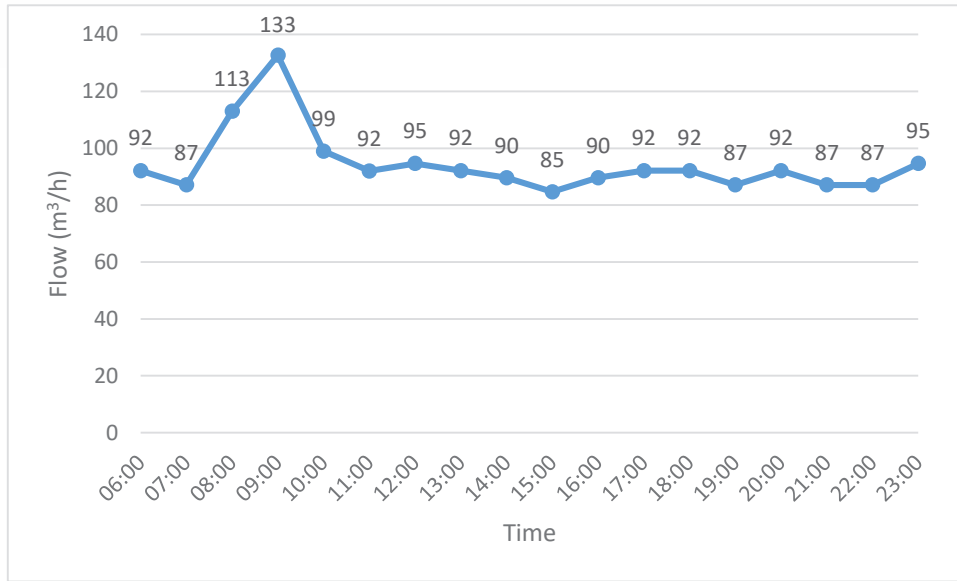

**COD Variation**

Figure 51 shows the COD variation in raw sewage and treated effluent. The minimum and maximum COD in the raw sewage varied from 187 mg/L to 1150 mg/L with a composite value of 447 mg/L. The time variable effluent COD concentration is in the range of 22 mg/L to 32 mg/L with a composite value of 27 mg/L.

**Figure 51: COD variation at STP**

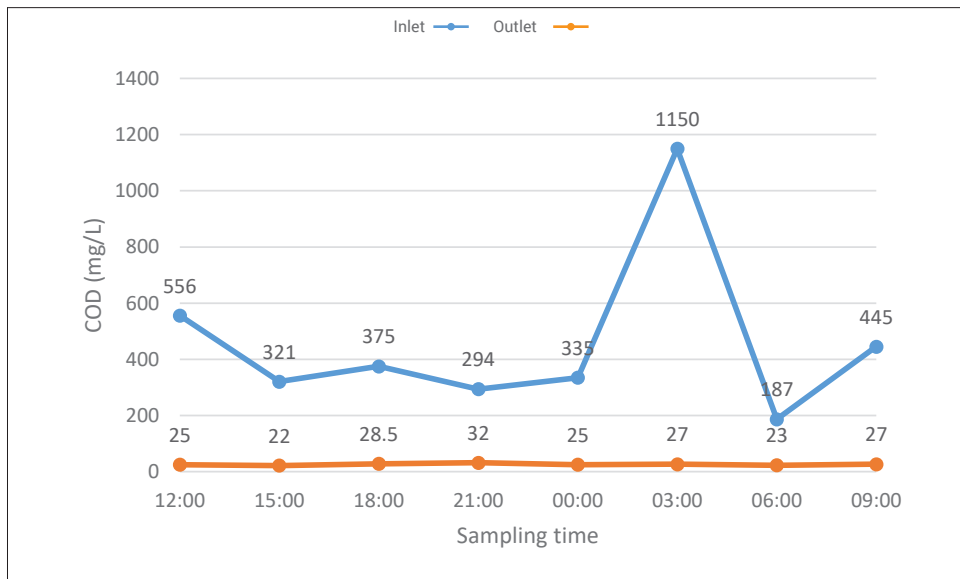

**BOD Variation**

Figure 52 shows the BOD variation in raw sewage and treated effluent. The minimum and maximum BOD in the raw sewage varied from 118 mg/L to 449 mg/L with a composite value of 265 mg/L. The time variable effluent BOD concentration is in the range of 3 mg/L to 8 mg/L with a composite value of 4 mg/L.

Figure 52: BOD variation at STP

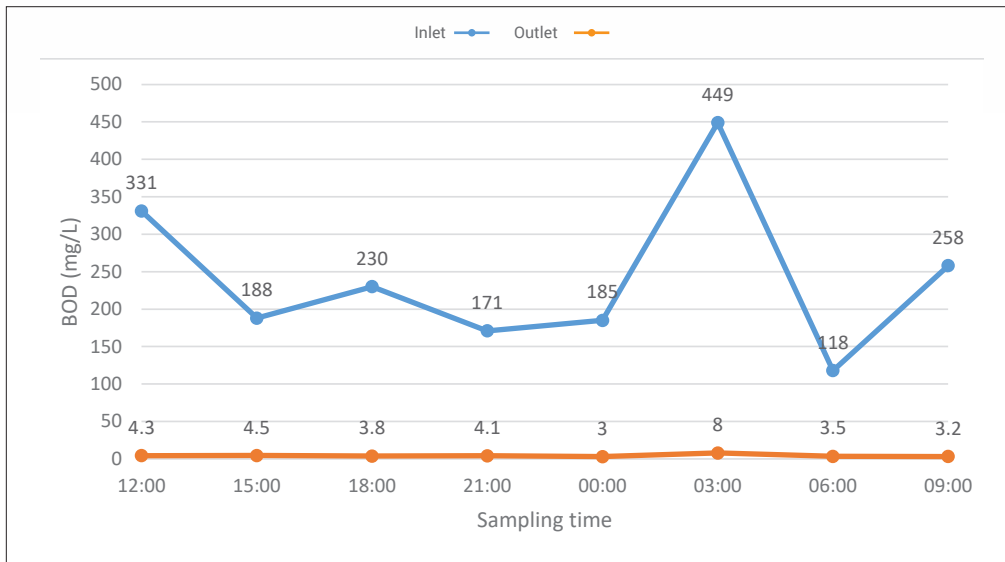

### TSS Variation

Figure 53 shows the TSS variation in raw sewage and treated effluent. The minimum and maximum TSS in the raw sewage varied from 110 mg/L to 790 mg/L with a composite value of 408 mg/L. The time variable effluent TSS concentration is in the range of 3.5mg/L to 8.5 mg/L with a composite value of 5.5 mg/L.

Figure 53: TSS variation at STP

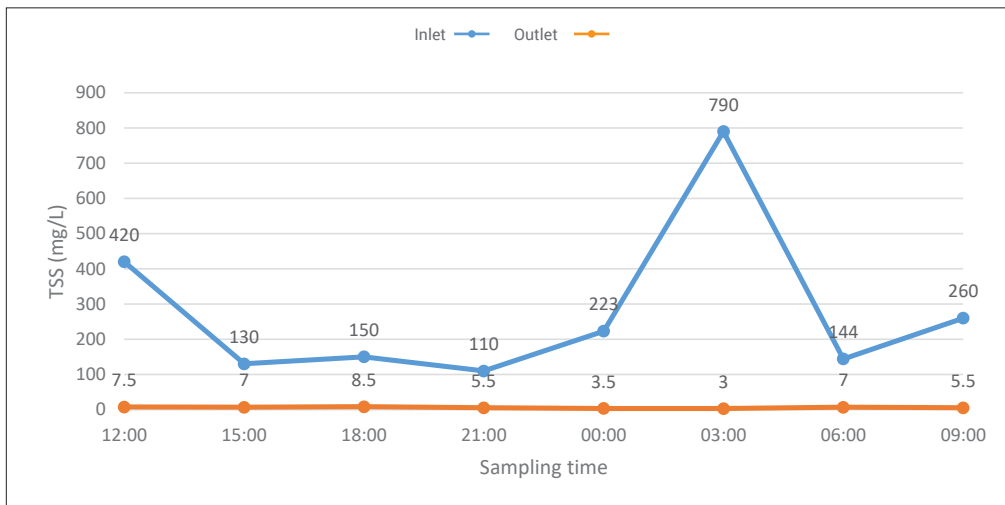

### 3.8.5. Composite sampling and analysis

For composite sampling, representative samples were collected at a regular time interval of 3-h on 6-7th July 2019. The flow rate was recorded by pump operation. The representative samples were then integrated by mixing together the portions of the individual samples relative to the flow rate at sampling time to make a composite sample. Analyses of alkalinity, COD, BOD, TSS,  $\text{NH}_4\text{-N}$ ,  $\text{NO}_3\text{-N}$ , and  $\text{PO}_4\text{-P}$  were carried out as per the Standard Methods (APHA, 2012) and presented in Table 36.

**Table 35: Results of Composite Sample**

S.No.	Parameters	Unit	Raw sewage	Outlet	Desired Effluent Quality
1	Alkalinity as CaCO <sub>3</sub>	mg/L	250	80	-
2	pH		6.8	7.6	-
3	Turbidity	NTU	180	1.8	-
4	BOD	mg/L	265	4	5
5	COD	mg/L	447	27	-
6	TSS	mg/L	408	5.5	10
7	NH <sub>4</sub> -N	mg/L	106.3	4.5	-
8	NO <sub>3</sub> -N	mg/L	1.4	12.5	-
9	TN	mg/L	111.1	18.3	-
10	PO <sub>4</sub> -P	mg/L	12.3	5.4	-

### 3.8.6 Strategies for septage addition for design and actual COD, BOD and TSS loadings

The design COD, BOD, and TSS loadings are summarized in the following Table 36. The safe load for septage addition is assumed as 80% of the design load. The safety factor is taken for consideration of harmful effects by Oil & Grease, cleaning agents, etc., on BOD, COD, TSS, and nutrient removal.

**Table 36: Design COD, BOD, and TSS Loading**

Parameter	Design Flow (m <sup>3</sup> /h)	Design Inlet Water Quality (mg/L)	Design Loading (kg/h)	Safe Loading for co-treatment with septage addition (80 % of Design Load)
BOD	208 m <sup>3</sup> /h	BOD = 300 mg/L or 0.3 kg/m <sup>3</sup>	208 m <sup>3</sup> /h x 0.3 kg/m <sup>3</sup> = 62.5 kg/h	0.8 x 62.5 kg/h = 49.9 or 50 kg/h
TSS	208 m <sup>3</sup> /h	TSS = 600 mg/L or 0.6 kg/m <sup>3</sup>	208 m <sup>3</sup> /h x 0.6 kg/m <sup>3</sup> = 124.8 kg/h	0.8 x 124.8kg/h = 99.8 or 100 kg/h

The assumed septage tanker loading in terms of COD, BOD and TSS is calculated as follows:

Assuming the volume of 1 truck/tanker = 3 m<sup>3</sup>

Therefore, organic loading of 1 truck/tanker

$$\text{COD loading} = 30 \text{ kg COD/m}^3 \times 3 \text{ m}^3/\text{truck} = 90 \text{ Kg COD/truck}$$

$$\text{BOD loading} = 20 \text{ kg BOD/m}^3 \times 3 \text{ m}^3/\text{truck} = 60 \text{ Kg BOD/truck}$$

$$\text{TSS loading} = 30 \text{ kg TSS/m}^3 \times 3 \text{ m}^3/\text{truck} = 90 \text{ kg TSS/truck}$$

The design, safe and actual COD, BOD, and TSS loading is plotted in figures 54-56.

**Figure 54: Actual BOD loading variation, Design BOD load, and safe design load**

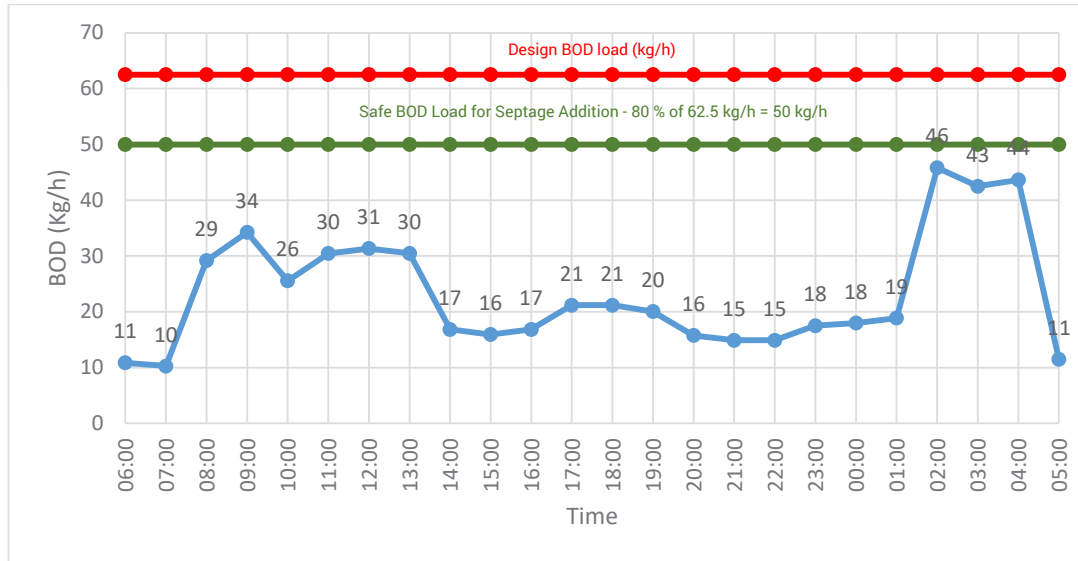

**Figure 55: Actual TSS loading variation, Design TSS load, and safe design load**

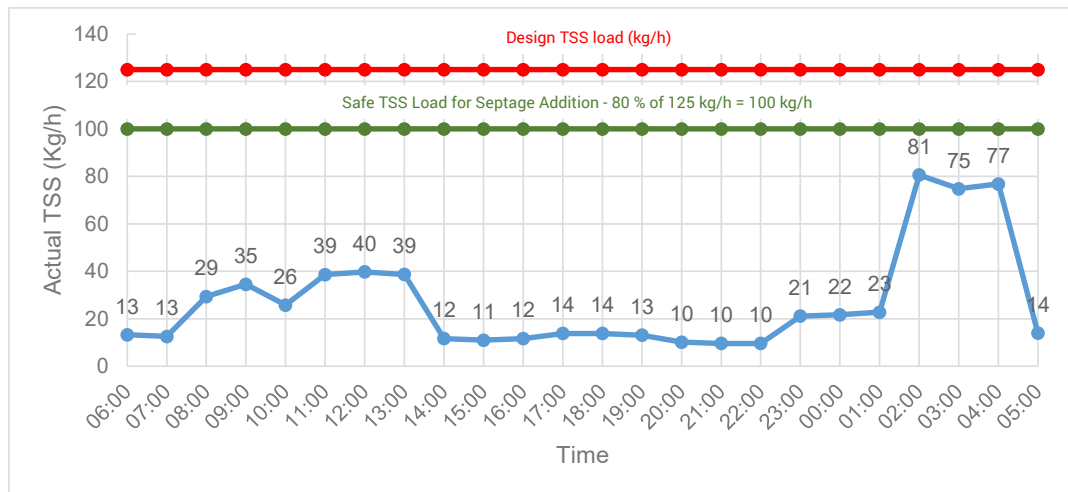

Actual BOD, and TSS loading during working hours (i.e., 6:00 a.m. to 1:00 a.m.) is lower than the design loading. Hence, co-treatment can be possible during working hour without any storage facility.

Assuming the volume of 1 truck/tanker = 3 m<sup>3</sup>

Therefore, organic loading of 1 truck/tanker

COD loading = 30000 mg/L x 3 m<sup>3</sup> /truck = 90 kg COD/truck

BOD loading = 20000 mg/L x 3 m<sup>3</sup> /truck = 60 kg BOD/truck

TSS loading = 30000 mg/L x 3 m<sup>3</sup> /truck = 90 kg TSS/truck

Table 37: Loading condition and disposing criteria

Duration	Considering BOD	Considering TSS
	Safe BOD loading = 50 kg/h	Safe TSS loading = 100 kg/h
	Septage Tanker load = 60 kg BOD/Tanker	Septage Tanker load = 90 kg TSS/Tanker
Between 6AM – 1AM (night)	Average actual BOD loading = 21 kg/h	Average actual TSS loading = 20 kg/h
	50 kg/h -21 kg/h = <b>29 kg/h or 0.5 truck/h can be disposed</b>	100kg/h – 20kg/h = <b>80 kg/h or 0.8 truck/h can be disposed</b>

Therefore, total no of trucks can be disposed = 19 x 0.5 trucks = 9.5 trucks  
 Volume of septage that can be disposed = 9.5 trucks × 3 m3 /truck = 28.5 m3

### 3.9. A Case-Study on Strategies of Co-Treatment of Septage at 3.5 MLD STP, Tapovan Rishikesh

#### 3.9.1 Introduction

The 3.5 MLD STP at Tapovan, Rishikesh is based on the SBR process. It was commissioned in April 2016. It comprises of receiving chamber, coarse screen (manual and mechanical), raw sewage sump, pump house, stilling chamber, fine screen (manual and mechanical), grit chamber, parshall flume, SBR basin, chlorine contact tank, sludge sump and centrifuge as shown in Figure 56.

#### 3.9.2 Flow Sheet

The typical flowsheet of STP is provided in Figure 56.

Figure 56: Flowsheet of 3.5 MLD SBR at Rishikesh

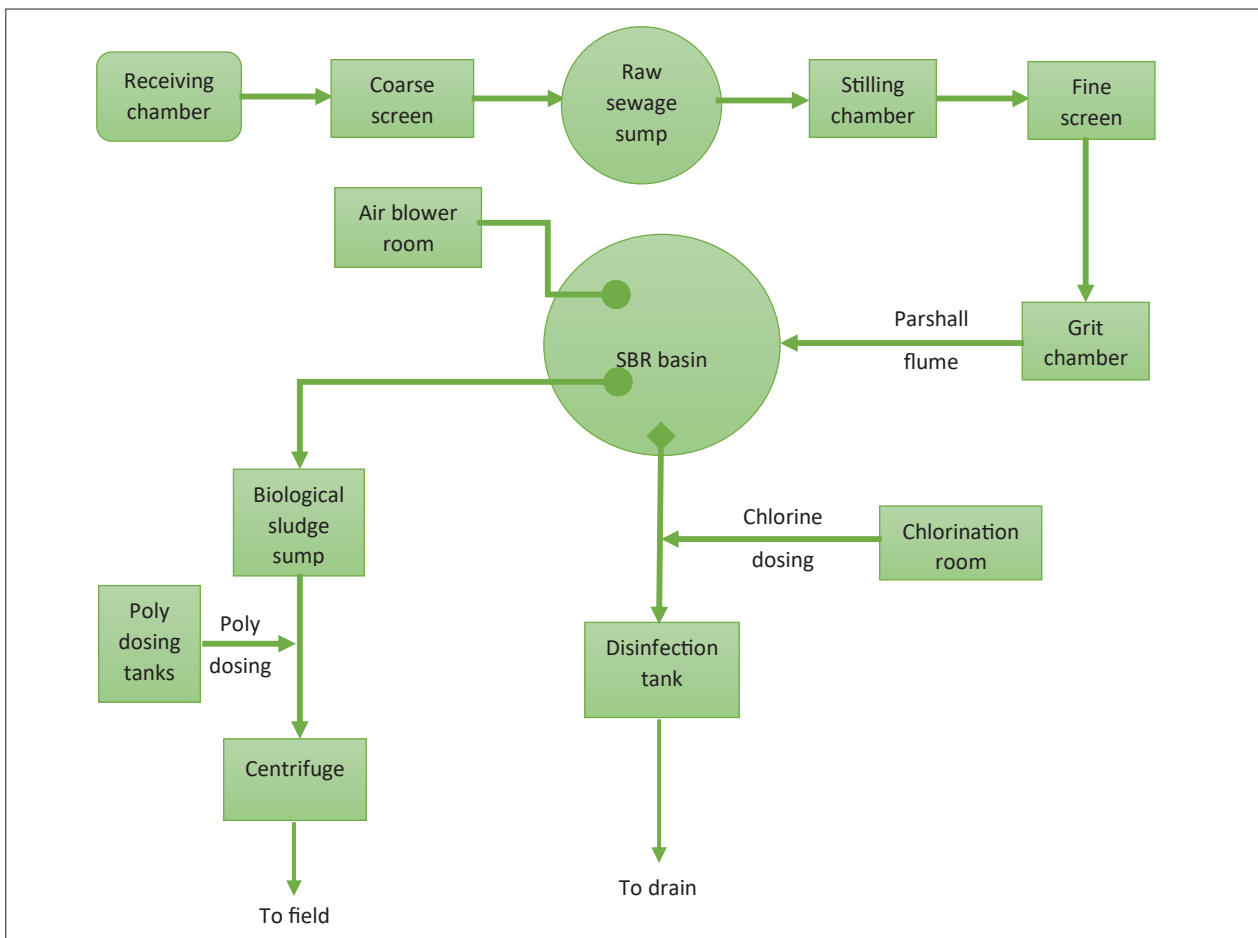

### 3.9.3. Design parameters & unit sizes

The STP is designed for an average flow of 3.5 MLD and a peak flow of 8.75 MLD. The design parameters are listed in Table 38. The unit sizes are summarized in Table 39.

**Table 38: Inlet and outlet water quality parameters**

S.No.	Parameter	Units	Influent	Effluent
1.	BOD	mg/L	250	<10
2.	COD	mg/L	450	<100
3.	TSS	mg/L	400	<10
4.	TKN	mg/L	15	-
5.	NH <sub>4</sub> -N	mg/L	8	<2
6.	T-N	mg/L	-	<10
7.	T-P	mg/L	5	<2

**Table 39: Unit Sizes of STP**

S. NO.	Description	Dimensions	No.
A	Intermediate sump	3700 dia x 2000 SWD	01
1	Stilling chamber	2000 x 1900 x 2000 SWD	01
2	Fine screen channel- (Mech)	6000 x 700 x 550 SWD	01
3	Fine screen channel- (Manual)	6000 x 500 x 600 SWD	01
4	Grit chamber- (Mech)	3800 x 3800 x 900 SWD	01
4A	Grit chamber- (manual)	1500 x 9500 x 900 SWD	01
5	Parshall flume	4500 length	01
6	SBR basins – (Two compartments)	27000 Dia x 4800 SWD	01
7	Disinfection tank	12500 x 6000 x 2000 SWD	01
8	Sludge sump	2700 x 2500 x 2500 SWD	01
9	SBR air blower, tool rm, workshop (gr fl) administrative, laboratory (first fl)	12500 x 8000 x 5500 ht	01
10	Disinfection room	6000 x 3500 x 3500 ht	01
11	Centrifuge house	6000 x 5000 x 9000 ht	01
12	Staff quarter	14750 x 6000 x 3000 ht	01
13	NaOCl dosing tank	1000 x 1000 x 500 SWD	01
14	Polymer dosing tank	800 x 800 x 1000 SWD	02
15	Watching cabin	3000 x 3000 x 3000 ht	01
16	H.T area	5000 x 5000	01
17	D.G. room	4000 x 5000 x 3000 ht	01
18	Sludge sump pump house	3000 x 6000 x 4500 ht	01
19	Plant bypass chamber	2000 x 2000 x 4800 deep	01

### 3.9.4. Flow and water quality analysis

#### Flow Variation

Flow variation is needed for obtaining peak and lean flows. The peak factor is one of the essential criteria for the design of preliminary treatment units and the flexibility of the biological process to handle peak flows. The observed average flow was 26 m<sup>3</sup>/h or 0.62 MLD, and peak flow was 60 m<sup>3</sup>/h with a peak factor of 2.3 on 13-14th Aug 2019, which is lower than the design peak factor. Figure 57 shows the flow variation.

Figure 57: Variation of inflow at STP

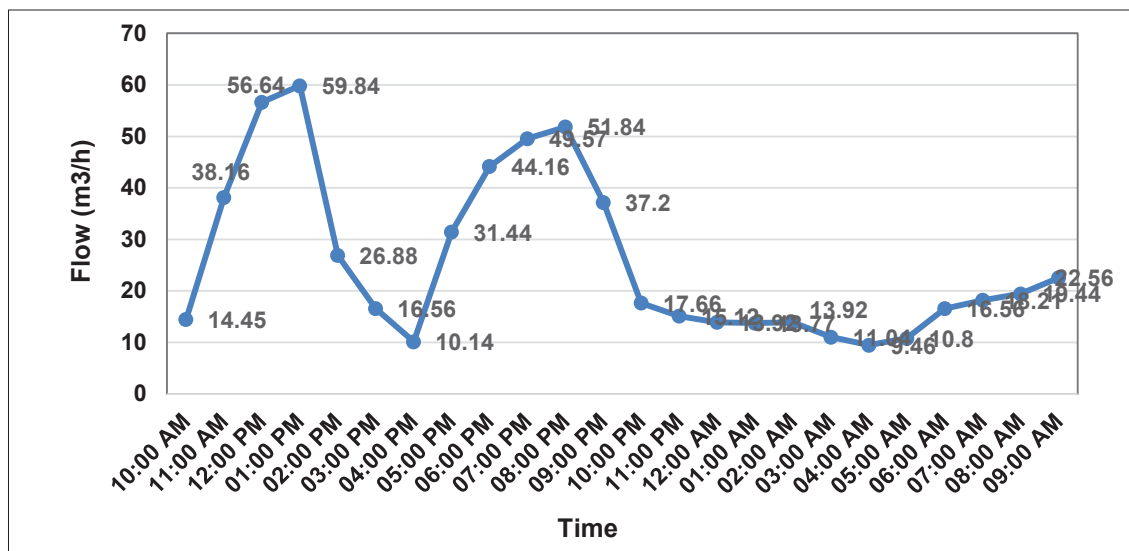

#### COD Variation

Figure 58 shows the COD variation in raw sewage and treated effluent. The minimum and maximum COD in the raw sewage varied from 281 mg/L to 642 mg/L with a composite value of 389 mg/L. The time variable effluent COD concentration is in the range of 22 mg/L to 19 mg/L with a composite value of 28 mg/L.

Figure 58: COD variation at STP

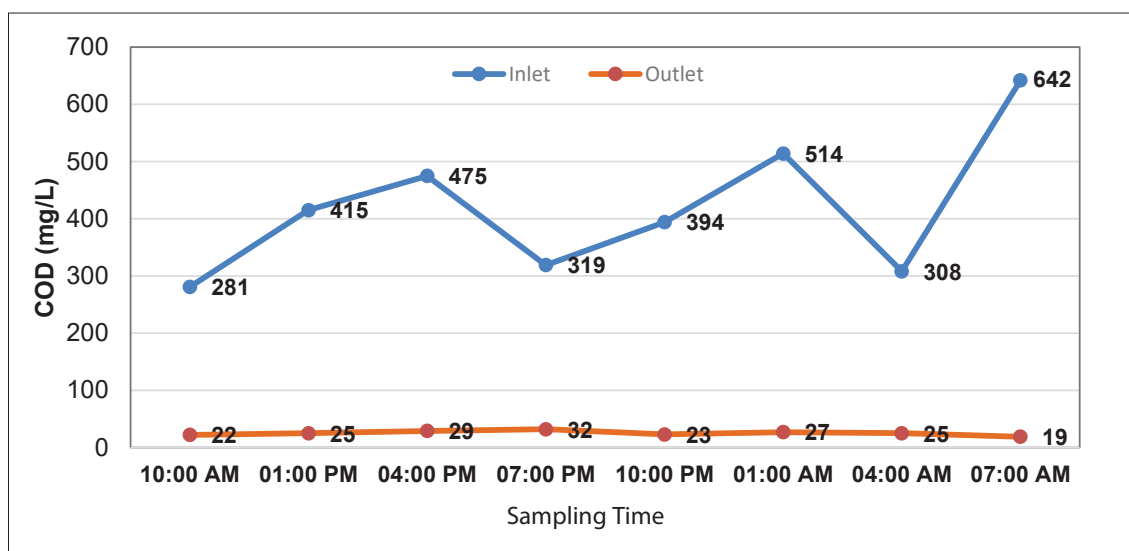

### BOD Variation

Figure 59 shows the BOD variation in raw sewage and treated effluent. The minimum and maximum BOD in the raw sewage varied from 159 mg/L to 288 mg/L with a composite value of 192 mg/L. The time variable effluent BOD concentration was in the range of 5 mg/L to 4 mg/L with a composite value of 5 mg/L.

Figure 59: BOD variation at STP

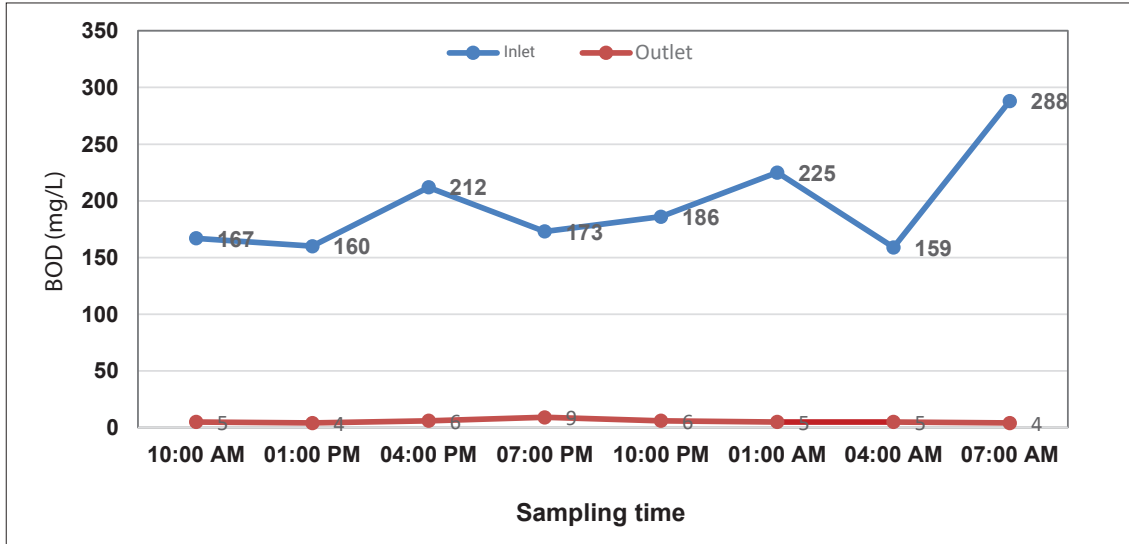

### TSS Variation

Figure 60 shows the TSS variation in raw sewage and treated effluent. The minimum and maximum TSS in the raw sewage varied from 202 mg/L to 319 mg/L with a composite value of 231 mg/L. The time variable effluent TSS concentration was in the range of 6 mg/L to 3 mg/L with a composite value of 6 mg/L.

Figure 60: TSS variation at STP

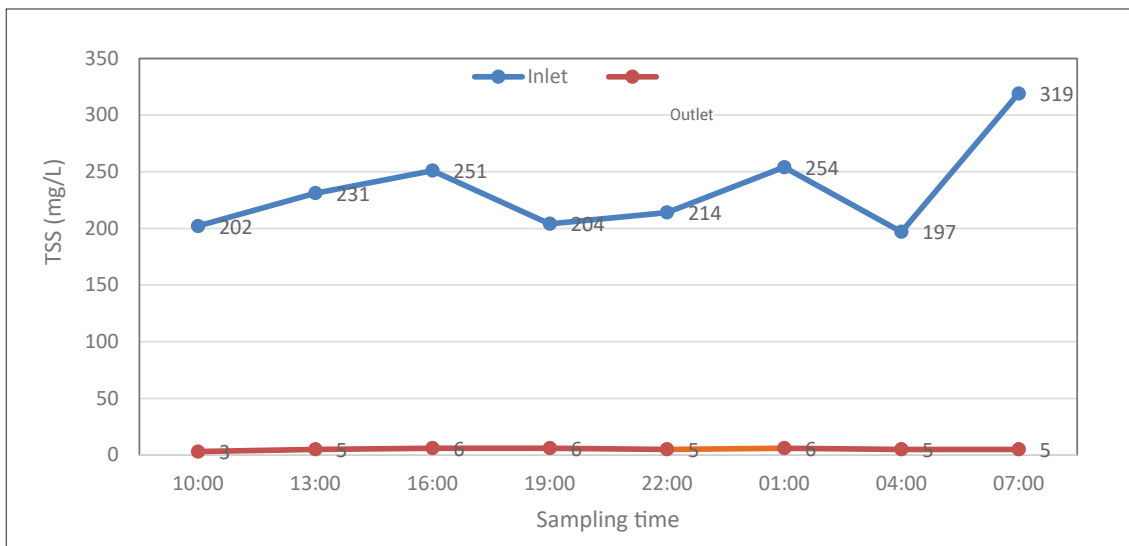



### 3.9.5. Composite sampling & analysis

For composite sampling, representative samples were collected at a regular time interval of 3-h on 13-14<sup>th</sup> August 2019. The flow rate was recorded by pump operation. The representative samples were then integrated by mixing together the portions of the individual samples relative to the flowrate at sampling time to make a composite sample. Analysis of alkalinity, COD, BOD, TSS, NH<sub>4</sub>-N, NO<sub>3</sub>-N, and PO<sub>4</sub>-P was carried out as per the Standard Methods (APHA, 2012) and presented in Table 40. The results show that almost all parameters satisfy the design outlet quality.

**Table 40: Results of Composite Sample**

Parameters	Unit	Inlet	Outlet	Desired Effluent Quality
Temp.	°C	19	19	-
pH	-	6.9	7.3	-
Color	-	Grayish	Colorless	-
Odor	-	Foul	Aseptic	-
Turbidity	NTU	64.8	0.6	-
Alkalinity	mg/L	360	340	-
Oil & Grease	mg/L	3.4	0.7	-
BOD	mg/L	192	5	10
COD	mg/L	389	28	100
TSS	mg/L	231	6	10
VSS	mg/L	147	1	-
NH <sub>4</sub> -N	mg/L	17.3	0.7	2
NO <sub>3</sub> -N	mg/L	0.3	2.6	-
TKN	mg/L	23	2	-
T-N	mg/L	23.3	4.6	10
PO <sub>4</sub> -P	mg/L	2.4	0.8	-
T-P	mg/L	4.3	1.3	2

### 3.9.6. Strategies for septage addition for design and actual COD, BOD and TSS loadings

The design COD, BOD, and TSS loadings are summarized in the following Table 41. The safe load for septage addition is assumed as 80% of the design load. The safety factor is taken for consideration of harmful effects by Oil & Grease, cleaning agents, etc., on BOD, COD, TSS, and nutrient removal.

**Table 41: Design COD, BOD, and TSS Loading**

Parameter	Design Flow (m <sup>3</sup> /h)	Design Inlet Water Quality (mg/L)	Design Loading (kg/h)	Safe Loading for co-treatment with septage addition (80 % of Design Load)
COD	3500 m <sup>3</sup> /d x 1 day/24 h = 146 m <sup>3</sup> /h	COD = 450 mg/L or 0.45 kg/m <sup>3</sup>	146 m <sup>3</sup> /h x 0.45 kg/m <sup>3</sup> = 65.7 kg/h	0.8 x 65.7kg/h = 52.5 or 53 kg/h
BOD	146 m <sup>3</sup> /h	BOD = 250 mg/L or 0.25 kg/m <sup>3</sup>	146 m <sup>3</sup> /h x 0.25 kg/m <sup>3</sup> = 36.5 kg/h	0.8 x 36.5 kg/h = 29.2 kg/h
TSS	146 m <sup>3</sup> /h	TSS = 400 mg/L or 0.40 kg/m <sup>3</sup>	146 m <sup>3</sup> /h x 0.4 kg/m <sup>3</sup> = 58.4 kg/h	0.8 x 58.4kg/h = 46.4 kg/h

The assumed septage tanker loading in terms of COD, BOD and TSS is calculated as follows:  
 Assuming the volume of 1 truck/tanker = 3 m<sup>3</sup>  
 Therefore, organic loading of 1 truck/tanker  
 COD loading = 30 kg COD/m<sup>3</sup> x 3 m<sup>3</sup>/truck = 90 kg COD/truck  
 BOD loading = 20 kg BOD/m<sup>3</sup> x 3 m<sup>3</sup>/truck = 60 kg BOD/truck  
 TSS loading = 30 kg TSS/m<sup>3</sup> x 3 m<sup>3</sup>/truck = 90 kg TSS/truck

The design, safe and actual COD, BOD, and TSS loading is plotted in figures 61-63.

Figure 61: Actual COD loading variation, Design COD load, and safe design load

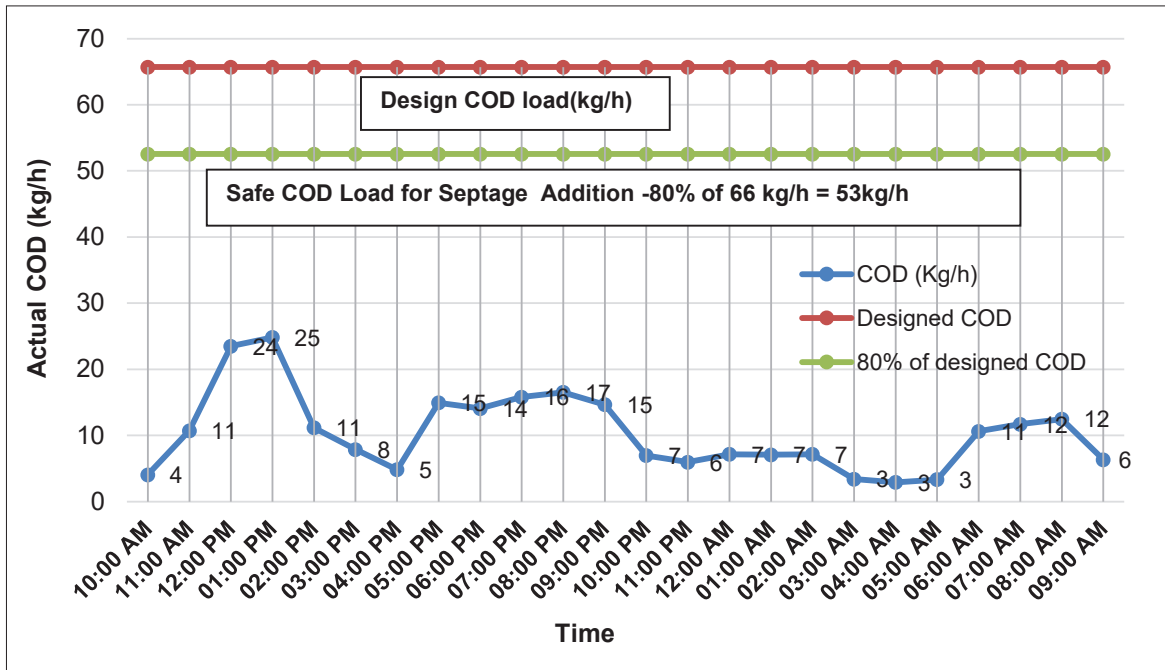

Figure 62: Actual BOD loading variation, Design BOD load, and safe design load

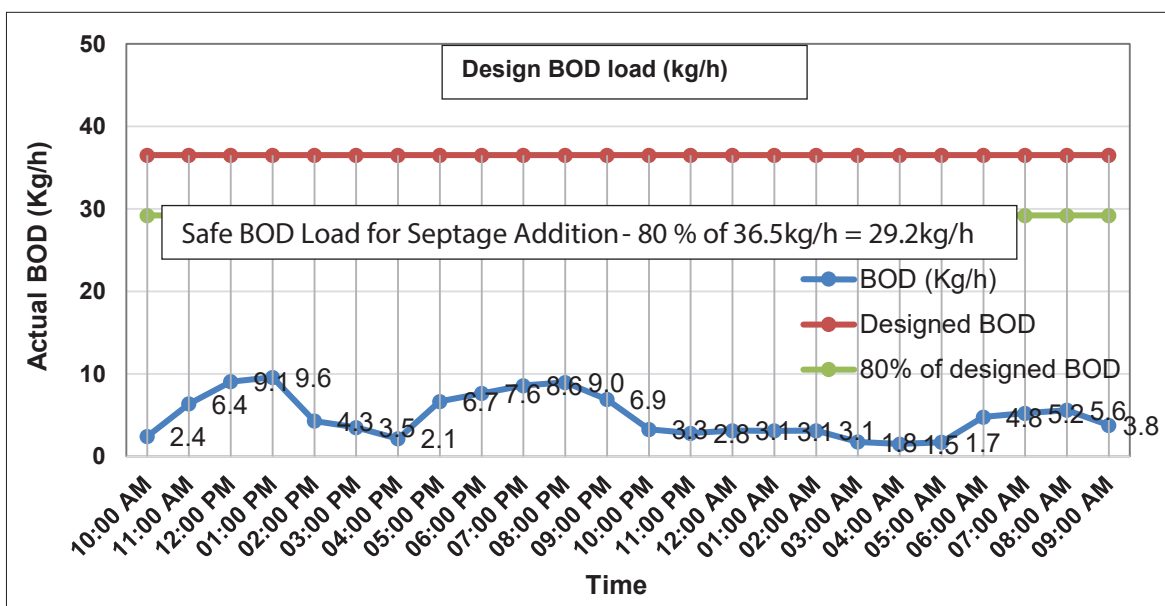
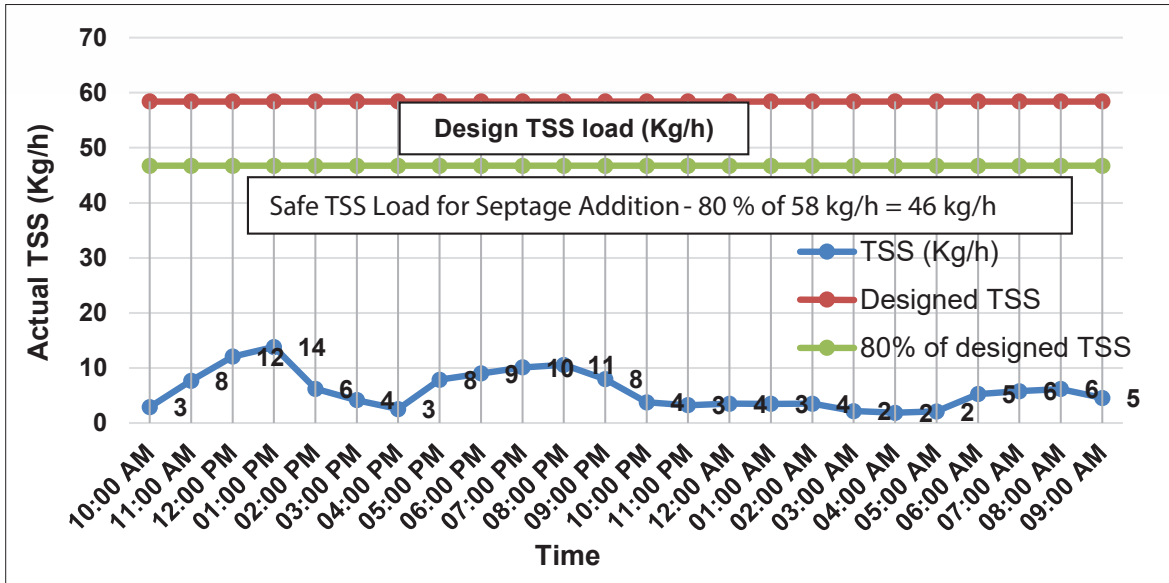

Figure 63: Actual TSS loading variation, Design TSS load, and safe design load



Actual COD, BOD, and TSS loading during full day is lower than safe design loading. Hence, co-treatment can be easily conducted during working hours without the provision of storage facility

Assuming the volume of 1 truck/tanker = 3 m<sup>3</sup>

Therefore, organic loading of 1 truck/tanker

COD loading = 30000 mg/L x 3 m<sup>3</sup>/truck = 90 kg COD/truck

BOD loading = 20000 mg/L x 3 m<sup>3</sup>/truck = 60 kg BOD/truck

TSS loading = 30000 mg/L x 3 m<sup>3</sup> /truck = 90 kg TSS/truck

Table42: Loading condition and disposing criteria

Duration	Considering COD	Considering BOD	Considering TSS
	Safe COD loading = 53 kg/h	Safe BOD loading = 29 kg/h	Safe TSS loading = 46.4 or 46kg/h
	Septage Tanker load = 90 kg COD/Tanker	Septage Tanker load = 60 kg BOD/Tanker	Septage Tanker load = 90 kg TSS/Tanker
24 hours	Average actual COD loading = 10 kg/h	Average actual BOD loading = 4.8 kg/h	Average actual TSS loading = 6 Kg/h
	53 kg/h - 10 kg/h = <b>43 kg/h or 0.5 truck/h can be disposed</b>	29 kg/h - 4.8 kg/h = <b>24.2 kg/h or 0.4 truck/h can be disposed</b>	46 kg/h - 6 kg/h = <b>40 kg/h or 0.5 truck/h can be disposed</b>

Total no of trucks can be disposed of = 24 × 0.4 truck = 9.6 or 10 trucks

Volume of septage that can be disposed = 10 truck × 3 m<sup>3</sup>/ truck = 30 m<sup>3</sup>

# 4. SEPTAGE RECEIVING FACILITY

Septage is 10 to 80 times more concentrated than typical sewage. Addition of septage to STP can hinder the operations and performance of the plant if it is not designed to handle septage. Some of the impacts of septage addition to STP include:

- Potential toxic shock to biological processes
- Increased odor emissions with resulting complaints from the public
- The increased volume of grit, scum, and screenings
- Increased organic loading to biological processes
- Potential odor and foaming problems in aerated basins
- Increased loading to sludge handling facilities
- Increased quantities of sludge requiring final disposal
- Increased housekeeping requirements

There are different ways to deal with concerns associated with STP performance when septage is added to it. The most common way is the controlled addition of the septage based on design and actual loading. To reduce the additional impact of septage, safe design loading can be reduced to 80%. Moreover, by providing a septage receiving station (SRS) that provides adequate raw solids screening and de-gritting, the risk of hindering the performance of the STP can be reduced. The SRS should also have additional features such as odor control, flow equalization, site monitoring, and access control. SRS is the most common way of pre-treatment of septage before it is co-treated at the STP. The main objectives of the septage receiving facility are

- Protection of the STP from toxic materials
- Prevent clogging of pumps
- Removing large solids via screening while returning organics to raw sewage
- Measuring volume of septage unloaded
- Preventing illegal discharges at STP
- Isolating, sampling and characterization of septage

The receiving septage facility generally consists of (Figure 65)

- (1) A septage unloading zone with a 150 mm diameter quick connection coupling and an access card reader system.
- (2) A rock trap, followed by a grinder (optional) and a flow meter.
- (3) A tank housing a 6 mm fine screen, auger, and screenings washer/compactor system.
- (4) A washed screenings bagging system.
- (5) Grit Removal System (Optional)
- (5) Holding tank with submersible transfer pumps

**Figure 64: Typical photographs of the septage receiving station**





Typical plan, section, and pictures of septicage receiving facility are provided in Figure 66.

**Figure 65: Typical plan and elevation of a septicage receiving station**

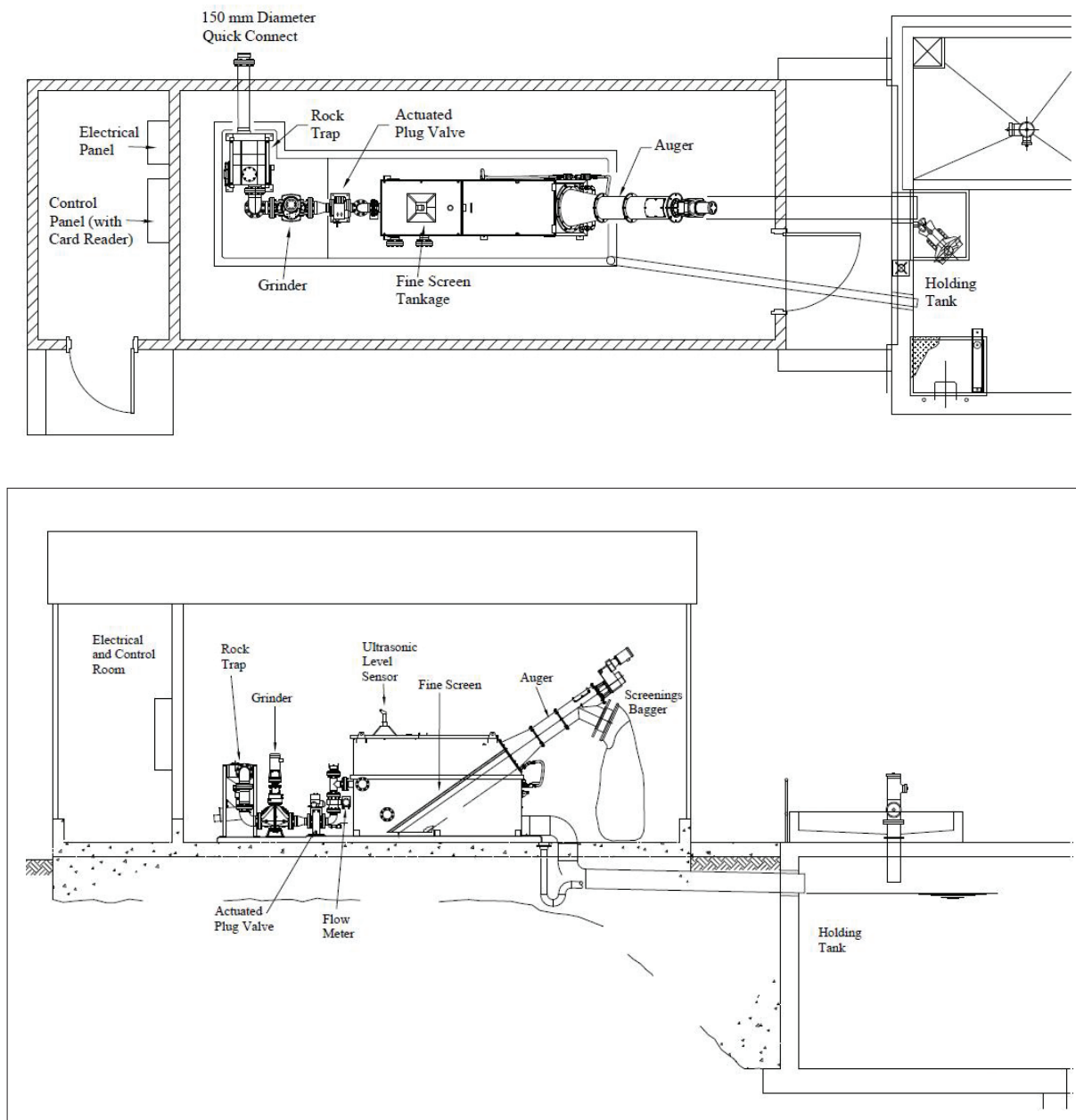





Download our latest reports, research briefs  
and training modules at:

[scbp.niua.org](http://scbp.niua.org)

#### **About NIUA**

NIUA is a premier national institute for research, capacity building and dissemination of knowledge in the urban sector, including sanitation. Established in 1976, it is the apex research body for the Ministry of Housing and Urban Affairs (MoHUA), Government of India. NIUA is also the strategic partner of the MoHUA in capacity building for providing single window services to the MoHUA/states/ULBs. The Institute includes amongst its present and former clients Housing and Urban Development Corporation, Niti Ayog, City and Industrial Development Corporation of Maharashtra, USAID, World Bank, Asian Development Bank, GIZ, UNICEF, UNEP, UNOPS, Cities Alliance, Bill & Melinda Gates Foundation, Rockefeller Foundation, Global Green Growth

#### **About SCBP**

Sanitation Capacity Building Platform (SCBP) is an initiative of the National Institute of Urban Affairs (NIUA) for addressing urban sanitation challenges in India. The 3 year programme (starting 2016) is supported by a Gates Foundation grant. It is aimed at promoting decentralised urban sanitation solutions for septage and waste water management. The Platform is an organic and growing collaboration of universities, training centres, resource centres, non-governmental organizations, consultants and experts. The Platform currently has on board CEPT University, CDD Society and BORDA, ASCI, AIILSG, UMC, ESF, CSE, WaterAid, CPR, iDECK, CSTEP and WASHi. The Platform works in close collaboration with the National Faecal Sludge and Septage Management Alliance (NFSSMA).



National Institute of Urban Affairs

### **National Institute of Urban Affairs**

1<sup>st</sup> Floor, Core 4B, India Habitat Centre, Lodhi Road, New Delhi - 110003  
Phone: 011-24617517, 24617543, 24617595, Fax: 011-24617513  
E-mail: [niua@niua.org](mailto:niua@niua.org) • Website: [www.niua.org](http://www.niua.org), [scbp.niua.org](http://scbp.niua.org)